

## Copper Compression Metric Lugs and Splices



- Optimum reliability and safety



**With Metric Conductors**



- Worldwide availability
- RoHS compliant
- Standard barrel lugs and splices for copper class 2r rigid stranded conductor sizes 4mm<sup>2</sup> – 630mm<sup>2</sup>, copper class 5f flexible stranded conductor sizes 4mm<sup>2</sup> – 300mm<sup>2</sup> and copper class 6f flexible stranded conductor sizes 10mm<sup>2</sup> – 240mm<sup>2</sup>
- NEW!** • Standard barrel lugs with 45° and 90° bent palms for copper class 2r rigid stranded conductor sizes 10mm<sup>2</sup> – 300 mm<sup>2</sup>, copper class 5f flexible stranded conductor sizes 10mm<sup>2</sup> – 300mm<sup>2</sup> and copper class 6f flexible stranded conductor sizes 10mm<sup>2</sup> – 240mm<sup>2</sup>
- Long barrel lugs for copper class 2r rigid stranded conductor sizes 10mm<sup>2</sup> – 630mm<sup>2</sup>, copper class 5f flexible stranded conductor sizes 10mm<sup>2</sup> – 300mm<sup>2</sup>, and copper class 6f flexible stranded conductor sizes 10mm<sup>2</sup> – 240mm<sup>2</sup>

### Key Features and Benefits

**Product Information Marked on Connector** for easy selection and installation

**99.9% Pure Copper and Tin Plated** to a nominal thickness of 320µ in (8µ m) to provide a high quality connection

**Inspection Window for Standard Barrel Lugs** allows a visually verifiable, high quality crimp



**Internally Beveled Wire Entry** for fast and easy installation



**Rounded Tongue for One-Hole Lugs** convenient for use in tight spaces

**UL Listed or UL Recognized and CSA Certified with Metric Conductors** allows specification to ensure safety and reliability

Product information marked on connector for easy selection and installation  
 Internally beveled wire entry for fast and easy installation  
 99.9% pure copper and tin plated to a nominal thickness of 320µ in ( 8µ m) to provide a high quality connection  
 Rounded tongue for one-hole lugs convenient for use in tight spaces  
 Inspection window for standard barrel lugs allows a visually verifiable, high quality crimp  
 UL Listed or UL Recognized and CSA Certified with metric conductors allows specification to ensure safety and reliability

# Part Number System

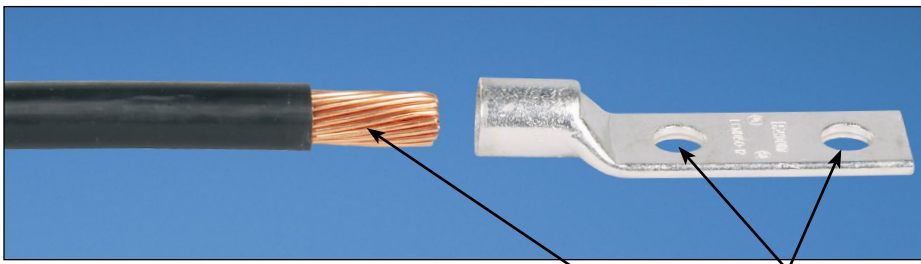

**LCMD**

**LCMA**

**Type**

- LCMD = Two-Hole Standard Barrel Lug, Class 2r, 5f and 6f
- LCMA = One-Hole Standard Barrel Lug, Class 2r, 5f and 6f
- SCMS = Splice, Class 2r, 5f and 6f
- LCMDX = Two-Hole Standard Barrel Lug, Class 5f and 6f
- LCMAX = One-Hole Standard Barrel Lug, Class 5f and 6f
- SCMSX = Splice, Class 5f and 6f
- LCMA-H = One-Hole Standard Barrel 45° Bent Lug, Class 2r, 5f and 6f
- LCMA-F = One-Hole Standard Barrel 90° Bent Lug, Class 2r, 5f and 6f
- LCMB = One-Hole Long Barrel Lug, Class 2r, 5f and 6f
- LCMC = Two-Hole Long Barrel Lug, Class 2r, 5f and 6f

\*Class 2r wire size

**150**

**150**

**Conductor Size**  
150 = 150mm<sup>2</sup>\*

**12**

**Stud Hole Size**  
12 = M12

**Two Stud Hole Spacing**  
No Letter = 44.5mm  
CD = 22.0 – 25.0mm  
00 = Blank Tongue

**-**

**H**  
Palm Angle  
H = 45°  
F = 90°  
No Letter = Straight

**X**

**Std. Pkg. Qty.**  
1 = 1 E = 20  
3 = 3 Q = 25  
5 = 5 L = 50  
6 = 6 C = 100  
X = 10

## Rigid and Flexible Strand Metric Copper Conductor, One-Hole, Standard Barrel with Inspection Window, Lugs

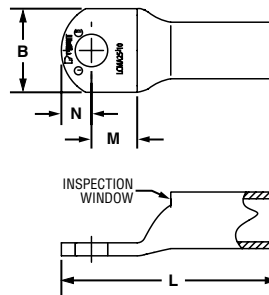

Figure 1.  
One-Hole

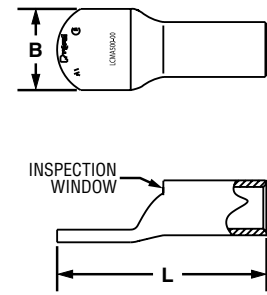

Figure 2.  
Blank Tongue



Part Number	Figure No.	Copper Conductor Size Class 2r (mm <sup>2</sup> )	Copper Conductor Size Class 5f/6f*** (mm <sup>2</sup> )	Stud Hole Size (mm)	Figure Dimensions (mm)					Std. Pkg. Qty.
					ØI	B	M	N	L	
LCMA6-5-C	1	4 – 6	4 – 6 ^	M5	3.8	10.0	7.8	6.2	27.5	100
LCMA6-6-C	1	4 – 6	4 – 6 ^	M6	3.8	10.8	7.8	6.2	27.5	100
LCMA6-8-C	1	4 – 6	4 – 6 ^	M8	3.8	13.0	8.0	8.0	30.5	100
LCMA10-5-C	1	10	—	M5	4.5	11.0	9.8	6.0	30.8	100
LCMA10-6-C	1	10	—	M6	4.5	11.0	9.8	6.0	30.8	100
LCMA10-8-C	1	10	—	M8	4.5	13.0	8.5	8.0	30.8	100
LCMA10-10-C	1	10	—	M10	4.4	14.5	8.5	8.0	30.8	100
LCMA16-5-C	1	16	10	M5	5.5	13.0	10.3	6.5	34.5	100
LCMA16-6-C	1	16	10	M6	5.5	13.0	10.3	6.5	34.5	100
LCMA16-8-C	1	16	10	M8	5.5	13.0	10.3	6.5	34.5	100
LCMA16-10-C	1	16	10	M10	5.5	15.0	10.2	8.0	36.7	100

‡See page 16 for tool and die information.

\*UL Recognized.

\*\*Consult cable manufacturer for voltage stress relief instructions with applications greater than 2000 V.

\*\*\*Not CE compliant and not tested to EN 61238-1:2003/IEC 61238-1:2003 for terminations with metric Class 5f or Class 6f flexible stranded conductor.

^ Class 5f conductor only

# Rigid and Flexible Strand Metric Copper Conductor, One-Hole, Standard Barrel with Inspection Window, Lugs

Part Number	Figure No.	Copper Conductor Size Class 2r (mm <sup>2</sup> )	Copper Conductor Size Class 5f/6f*** (mm <sup>2</sup> )	Stud Hole Size (mm)	Figure Dimensions (mm)					Std. Pkg. Qty.
					ØI	B	M	N	L	
LCMA25-6-C	1	25	16	M6	6.9	14.0	10.0	8.0	37.0	100
LCMA25-8-C	1	25	16	M8	6.9	15.5	10.0	8.0	37.0	100
LCMA25-10-C	1	25	16	M10	6.9	15.5	10.0	8.0	37.0	100
LCMA35-6-C	1	35	25	M6	8.2	15.5	12.3	8.5	42.0	100
LCMA35-8-C	1	35	25	M8	8.2	15.5	12.3	8.5	42.0	100
LCMA35-10-C	1	35	25	M10	8.2	15.5	12.3	8.5	42.0	100
LCMA35-12-C	1	35	25	M12	8.2	21.5	14.5	11.5	48.0	100
LCMA50-6-L	1	50	35	M6	9.8	18.0	11.5	10.0	46.5	50
LCMA50-8-L	1	50	35	M8	9.8	18.0	11.5	10.0	46.5	50
LCMA50-10-L	1	50	35	M10	9.8	18.0	11.5	10.0	46.5	50
LCMA50-12-L	1	50	35	M12	9.8	23.0	14.0	11.0	50.0	50
LCMA70-6-L	1	70	50	M6	11.5	20.8	14.5	11.5	53.5	50
LCMA70-8-L	1	70	50	M8	11.5	20.8	14.5	11.5	53.5	50
LCMA70-10-L	1	70	50	M10	11.5	20.8	14.5	11.5	53.5	50
LCMA70-12-L	1	70	50	M12	11.5	20.8	14.5	11.5	53.5	50
LCMA95-8-L	1	95	70	M8	13.5	24.5	15.0	13.5	60.5	50
LCMA95-10-L	1	95	70	M10	13.5	24.5	15.0	13.5	60.5	50
LCMA95-12-L	1	95	70	M12	13.5	24.5	15.0	13.5	60.5	50
LCMA95-16-L	1	95	70	M16	13.5	24.5	15.0	13.5	60.5	50
LCMA120-8-L	1	120	95	M8	15.2	27.5	15.5	14.5	65.0	50
LCMA120-10-L	1	120	95	M10	15.2	27.5	15.5	14.5	65.0	50
LCMA120-12-L	1	120	95	M12	15.2	27.5	15.5	14.5	65.0	50
LCMA120-16-L	1	120	95	M16	15.2	27.5	15.5	14.5	65.0	50
LCMA150-8-X	1	150	120	M8	16.5	30.5	18.0	16.5	70.5	10
LCMA150-10-X	1	150	120	M10	16.5	30.5	18.0	16.5	70.5	10
LCMA150-12-X	1	150	120	M12	16.5	30.5	18.0	16.5	70.5	10
LCMA150-16-X	1	150	120	M16	16.5	30.5	18.0	16.5	70.5	10
LCMA150-20-X	1	150	120	M20	16.5	30.5	22.0	16.5	74.0	10
LCMA185-10-X	1	185	150	M10	18.6	33.5	16.5	17.5	72.5	10
LCMA185-12-X	1	185	150	M12	18.6	33.5	16.5	17.5	72.5	10
LCMA185-16-X	1	185	150	M16	18.6	33.5	16.5	17.5	72.5	10
LCMA185-20-X	1	185	150	M20	18.6	33.5	21.0	17.5	77.0	10
LCMA240-10-X	1	240	185	M10	20.8	37.5	21.0	19.5	86.5	10
LCMA240-12-X	1	240	185	M12	20.8	37.5	21.0	19.5	86.5	10
LCMA240-16-X	1	240	185	M16	20.8	37.5	21.0	19.5	86.5	10
LCMA240-20-X	1	240	185	M20	20.8	37.5	21.0	19.5	86.5	10
LCMA300-10-5	1	300	240	M10	23.5	42.5	22.0	20.0	94.5	5
LCMA300-12-5	1	300	240	M12	23.5	42.5	22.0	20.0	94.5	5
LCMA300-16-5	1	300	240	M16	23.5	42.5	22.0	20.0	94.5	5
LCMA300-20-5	1	300	240	M20	23.5	42.5	22.0	20.0	94.5	5
LCMAX300-10-5	1	—	300 <sup>^</sup>	M10	26.2	48.0	26.5	23.5	107.0	5
LCMAX300-12-5	1	—	300 <sup>^</sup>	M12	26.2	48.0	26.5	23.5	107.0	5
LCMAX300-16-5	1	—	300 <sup>^</sup>	M16	26.2	48.0	26.5	23.5	107.0	5
LCMAX300-20-5	1	—	300 <sup>^</sup>	M20	26.2	48.0	26.5	23.5	107.0	5
LCMA400-12-5	1	400	—	M12	27.0	49.5	26.5	23.5	107.0	5
LCMA400-16-5	1	400	—	M16	27.0	49.5	26.5	23.5	107.0	5
LCMA400-20-5	1	400	—	M20	27.0	49.5	26.5	23.5	107.0	5
LCMA500-12-1	1	500	—	M12	31.0	57.5	28.5	25.5	120.0	1
LCMA500-16-1	1	500	—	M16	31.0	57.5	28.5	25.5	120.0	1
LCMA500-20-1	1	500	—	M20	31.0	57.5	28.5	25.5	120.0	1
LCMA500-00-1	2	500	—	Blank	31.0	57.5	—	—	120.0	1
LCMA630-16-1	1	630	—	M16	34.5	63.0	28.5	27.5	131.0	1
LCMA630-20-1	1	630	—	M20	34.5	63.0	28.5	27.5	131.0	1
LCMA630-00-1	2	630	—	Blank	34.5	63.0	—	—	131.0	1

‡See page 16 for tool and die information.

\*\*Consult cable manufacturer for voltage stress relief instructions with applications greater than 2000 V.

\*\*\*Not CE compliant and not tested to EN 61238-:2003/IEC 61238-1:2003 for terminations with metric Class 5f or Class 6f flexible stranded conductor.

<sup>^</sup> Class 5f conductor only

# Rigid and Flexible Strand Metric Copper Conductor, Two-Hole, Standard Barrel with Inspection Window, Lugs

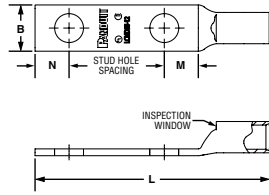

Figure 1.  
Two-Hole

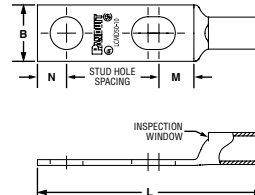

Figure 2.  
Two-Hole Slotted

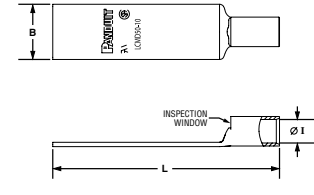

Figure 3.  
Blank Tongue



CE and EN 61238-1:2003/IEC 61238-1:2003 Class B, sizes 4mm<sup>2</sup> – 630mm<sup>2</sup> Class 2r

Part Number	Figure No.	Copper Conductor Size Class 2r (mm <sup>2</sup> )	Copper Conductor Size Class 5f/6f*** (mm <sup>2</sup> )	Stud Hole Size (mm)	Stud Hole Spacing (mm)	Figure Dimensions (mm)					Panduit Die Index No.‡	Std. Pkg. Qty.
						Ø1	B	M	N	L		
LCMD6-5CD-Q	2	4 – 6	4-6^	M5	22.0 – 25.0	3.8	10.0	7.8	6.2	52.5	P10	25
LCMD10-6CD-Q	2	10	—	M6	22.0 – 25.0	4.5	11.0	9.8	6.0	55.8	P21	25
LCMD10-8-Q	1	10	—	M8	44.5	4.5	13.0	8.5	8.0	75.3	P21	25
LCMD10-00-Q	3	10	—	Blank	—	4.4	14.5	—	—	75.3	P21	25
LCMD16-6CD-Q	2	16	10	M6	22.0 – 25.0	5.5	13.0	10.3	6.5	59.5	P24	25
LCMD16-8-Q	1	16	10	M8	44.5	5.5	13.0	10.3	6.5	79.0	P24	25
LCMD16-00-Q	3	16	10	Blank	—	5.5	15.0	—	—	81.2	P24	25
LCMD25-8CD-Q	2	25	16	M8	22.0 – 25.0	6.9	15.5	10.0	8.0	62.0	P29	25
LCMD25-8-Q	1	25	16	M8	44.5	6.9	15.5	10.0	8.0	81.5	P29	25
LCMD25-10-Q	1	25	16	M10	44.5	6.9	15.5	10.0	8.0	81.5	P29	25
LCMD25-12-Q	1	25	16	M12	44.5	7.1	20.0	14.5	11.5	89.5	P29	25
LCMD25-00-Q	3	25	16	Blank	—	7.1	20.0	—	—	89.5	P29	25
LCMD35-8CD-Q	2	35	25	M8	22.0 – 25.0	8.2	15.5	12.3	8.5	67.0	P29	25
LCMD35-10-Q	1	35	25	M10	44.5	8.2	15.5	12.3	8.5	86.5	P29	25
LCMD35-12-Q	1	35	25	M12	44.5	8.2	21.5	14.5	11.5	92.5	P29	25
LCMD35-00-Q	3	35	25	Blank	—	8.2	21.5	—	—	92.5	P29	25
LCMD50-10CD-X	2	50	35	M10	22.0 – 25.0	9.8	18.0	11.5	10.0	71.5	P37	10
LCMD50-10-X	1	50	35	M10	44.5	9.8	18.0	11.5	10.0	91.0	P37	10
LCMD50-12-X	1	50	35	M12	44.5	9.8	23.0	14.0	11.0	94.5	P37	10
LCMD50-00-X	3	50	35	Blank	—	9.8	23.0	—	—	94.5	P37	10
LCMD70-10CD-X	2	70	50	M10	22.0 – 25.0	11.5	20.5	14.5	11.0	78.5	P45	10
LCMD70-10-X	1	70	50	M10	44.5	11.5	20.8	14.5	11.5	98.0	P45	10
LCMD70-12-X	1	70	50	M12	44.5	11.5	20.8	14.5	11.5	98.0	P45	10
LCMD70-00-X	3	70	50	Blank	—	11.5	20.8	—	—	98.0	P45	10
LCMD95-10CD-X	2	95	70	M10	22.0 – 25.0	13.5	24.5	15.0	13.0	85.5	P54	10
LCMD95-12-X	1	95	70	M12	44.5	13.5	24.5	15.0	13.5	105.0	P54	10
LCMD95-14-X	1	95	70	M14	44.5	13.5	24.5	15.0	13.5	105.0	P54	10
LCMD95-00-X	3	95	70	Blank	—	13.5	24.5	—	—	105.0	P54	10
LCMD120-10CD-X	2	120	95	M10	22.0 – 25.0	15.2	27.5	15.5	14.0	90.0	P62	10
LCMD120-12-X	1	120	95	M12	44.5	15.2	27.5	15.5	14.5	109.5	P62	10
LCMD120-14-X	1	120	95	M14	44.5	15.2	27.5	15.5	14.5	109.5	P62	10
LCMD120-00-X	3	120	95	Blank	—	15.2	27.5	—	—	109.5	P62	10
LCMD150-10CD-X	2	150	120	M10	22.0 – 25.0	16.5	30.5	18.0	16.0	95.5	P66	10
LCMD150-12-X	1	150	120	M12	44.5	16.5	30.5	18.0	16.5	115.0	P66	10
LCMD150-14-X	1	150	120	M14	44.5	16.5	30.5	22.0	16.5	118.5	P66	10
LCMD150-00-X	3	150	120	Blank	—	16.5	30.5	—	—	118.5	P66	10
LCMD185-10CD-X	2	185	150	M10	22.0 – 25.0	18.6	33.5	16.5	17.0	97.5	P76	10
LCMD185-12-X	1	185	150	M12	44.5	18.6	33.5	16.5	17.5	117.0	P76	10
LCMD185-14-X	1	185	150	M14	44.5	18.6	33.5	21.0	17.5	121.5	P76	10
LCMD185-00-X	3	185	150	Blank	—	18.6	33.5	—	—	121.5	P76	10
LCMD240-10CD-5	2	240	185	M10	22.0 – 25.0	20.8	37.5	21.0	19.0	111.5	P87	5
LCMD240-12-5	1	240	185	M12	44.5	20.8	37.5	21.0	19.5	131.0	P87	5
LCMD240-14-5	1	240	185	M14	44.5	20.8	37.5	21.0	19.5	131.0	P87	5

‡See page 16 for tool and die information.

\* UL Recognized.

\*\*Consult cable manufacturer for voltage stress relief instructions with applications greater than 2000 V.

\*\*\*Not CE compliant and not tested to EN 61238-1:2003/IEC 61238-1:2003 for terminations with metric Class 5f or Class 6f flexible stranded conductor.

^ Class 5f conductor only

# Rigid and Flexible Strand Metric Copper Conductor, Two-Hole, Standard Barrel with Inspection Window, Lugs



and EN 61238-1:2003/IEC 61238-1:2003 Class B, sizes 4mm<sup>2</sup> – 630mm<sup>2</sup> Class 2r

Part Number	Figure No.	Copper Conductor Size Class 2r (mm <sup>2</sup> )	Copper Conductor Size class 5f/6f*** (mm <sup>2</sup> )	Stud Hole Size (mm)	Stud Hole Spacing (mm)	Figure Dimensions (mm)					Std. Pkg. Qty.
						ØI	B	M	N	L	
LCMD240-00-5	3	240	185	Blank	—	20.8	37.5	—	—	131.0	5
LCMD300-12-5	1	300	240	M12	44.5	23.5	42.5	22.0	20.0	139.0	5
LCMD300-14-5	1	300	240	M14	44.5	23.5	42.5	22.0	20.0	139.0	5
LCMD300-00-5	3	300	240	Blank	—	23.5	42.5	—	—	139.0	5
LCMDX300-12-5	1	—	300 <sup>^</sup>	M12	44.5	26.2	48.0	26.5	23.5	151.5	5
LCMDX300-14-5	1	—	300 <sup>^</sup>	M14	44.5	26.2	48.0	26.5	23.5	151.5	5
LCMDX300-00-5	3	—	300 <sup>^</sup>	Blank	—	26.2	48.0	—	—	151.5	5
LCMD400-12-5	1	400	—	M12	44.5	27.0	49.5	26.5	23.5	151.5	5
LCMD400-14-5	1	400	—	M14	44.5	27.0	49.5	26.5	23.5	151.5	5
LCMD400-16-5	1	400	—	M16	44.5	27.0	49.5	26.5	23.5	151.5	5
LCMD400-00-5	3	400	—	Blank	—	27.0	49.5	—	—	151.5	5
LCMD500-12-1	1	400	—	M12	44.5	31.0	57.5	28.5	25.5	164.5	1
LCMD500-14-1	1	400	—	M14	44.5	31.0	57.5	28.5	25.5	164.5	1
LCMD500-16-1	1	400	—	M16	44.5	31.0	57.5	28.5	25.5	164.5	1
LCMD500-00-1*	3	500	—	Blank	—	31.0	57.5	—	—	164.5	1
LCMD630-12-1	1	630	—	M12	44.5	34.5	63.0	28.5	27.5	175.5	1
LCMD630-14-1	1	630	—	M14	44.5	34.5	63.0	28.5	27.5	175.5	1
LCMD630-16-1	1	630	—	M16	44.5	34.5	63.0	28.5	27.5	175.5	1
LCMD630-00-1	3	630	—	Blank	—	34.5	63.0	—	—	175.5	1

‡See page 16 for tool and die information.

\* UL Recognized.

\*\*Consult cable manufacturer for voltage stress relief instructions with applications greater than 2000 V.

\*\*\*Not CE compliant and not tested to EN 61238-1:2003/IEC 61238-1:2003 for terminations with metric Class 5f or Class 6f flexible stranded conductor.

<sup>^</sup> Class 5f conductor only

# Rigid and Flexible Strand Metric Copper Conductor, Standard Barrel, Butt Splice

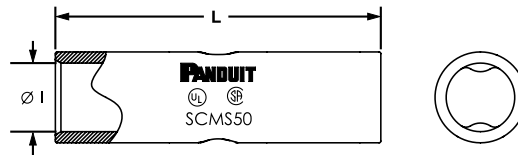

and EN 61238-1:2003/IEC 61238-1:2003 Class B, sizes 10mm<sup>2</sup> – 630mm<sup>2</sup> Class 2r

Part Number	Copper Conductor Size Class 2r (mm <sup>2</sup> )	Copper Conductor Size class 5f/6f*** (mm <sup>2</sup> )	Figure Dimensions (mm)		Std. Pkg. Qty.
			ØI	L	
SCMS10-C*	10	—	4.5	30.0	100
SCMS16-C*	16	10	5.5	35.0	100
SCMS25-L	25	16	6.9	36.0	50
SCMS35-L	35	25	8.2	36.0	50
SCMS50-L	50	35	9.8	49.0	50
SCMS70-L	70	50	11.5	52.0	50
SCMS95-Q	95	70	13.5	54.0	25
SCMS120-Q	120	95	15.2	57.0	25
SCMS150-X	150	120	16.5	57.0	10
SCMS185-X	185	150	18.6	61.0	10
SCMS240-X	240	185	20.8	72.0	10
SCMS300-5	300	240	23.5	75.0	5
SCMSX300-5	—	300 <sup>^</sup>	26.2	95.0	5
SCMS400-5	400	—	27.0	95.0	5
SCMS500-6	500	—	31.0	96.0	6
SCMS630-6	630	—	34.5	131.0	6

‡See page 16 for tool and die information.

\* UL Recognized.

\*\*Consult cable manufacturer for voltage stress relief instructions with applications greater than 2000 V.

\*\*\*Not CE compliant and not tested to EN 61238-1:2003/IEC 61238-1:2003 for terminations with metric Class 5f or Class 6f flexible stranded conductor.

<sup>^</sup> Class 5f conductor only

# Rigid and Flexible Stranded Metric Conductor, One-Hole, Standard Barrel with Window Lug, 45° Angle

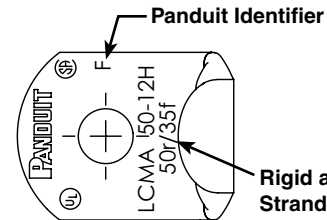
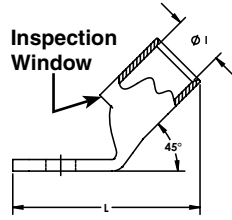
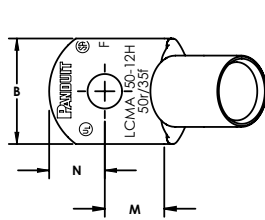

To 35 KV\*\*  
Rated to 90°C

CE and EN 61238-1:2003/IEC 61238-1:2003 Class B, sizes 10mm<sup>2</sup> – 240mm<sup>2</sup> Class 2r

Part Number	Copper Conductor Size Class 2r (mm <sup>2</sup> )	Copper Conductor Size Class 5f/6f <sup>^</sup> (mm <sup>2</sup> )	Stud Hole Size (mm)	Figure Dimensions (mm)					Std. Pkg. Qty.
				ØI	B	M	N	L	
LCMA10-5H-C	10	—	M5	4.5	11.0	9.8	6.0	27.6	100
LCMA10-6H-C	10	—	M6	4.5	11.0	9.8	6.0	27.6	100
LCMA10-8H-C	10	—	M8	4.5	13.0	8.5	8.0	27.7	100
LCMA10-10H-C	10	—	M10	4.4	14.5	8.5	8.0	28.0	100
LCMA16-5H-C	16	10	M5	5.5	13.0	10.3	6.5	30.4	50
LCMA16-6H-C	16	10	M6	5.5	13.0	10.3	6.5	30.4	100
LCMA16-8H-C	16	10	M8	5.5	13.0	10.3	6.5	30.3	100
LCMA16-10H-C	16	10	M10	5.5	15.0	10.2	8.0	32.3	100
LCMA25-6H-C	25	16	M6	6.9	14.0	10.0	8.0	31.8	100
LCMA25-8H-C	25	16	M8	6.9	15.5	10.0	8.0	31.8	100
LCMA25-10H-C	25	16	M10	6.9	15.5	10.0	8.0	31.7	100

See page 18 for tool and die information.

\*Class 5f conductor only.

\*\*Consult cable manufacturer for voltage stress relief instructions with applications greater than 2000 V.

<sup>^</sup>Not CE compliant and not tested to EN 61238-1:2003/IEC 61238-1:2003 for terminations with metric Class 5f or Class 6f flexible stranded conductor.

# Rigid and Flexible Stranded Metric Conductor, One-Hole, Standard Barrel with Window Lug, 45° Angle (continued)



and EN 61238-1:2003/IEC 61238-1:2003 Class B, sizes 10mm<sup>2</sup> – 240mm<sup>2</sup> Class 2r

Part Number	Copper Conductor Size Class 2r (mm <sup>2</sup> )	Copper Conductor Size Class 5f/6f <sup>^</sup> (mm <sup>2</sup> )	Stud Hole Size (mm)	Figure Dimensions (mm)					Std. Pkg. Qty.
				ØI	B	M	N	L	
LCMA35-6H-C	35	25	M6	8.2	15.5	12.3	8.5	36.7	100
LCMA35-8H-C	35	25	M8	8.2	15.5	12.3	8.5	36.7	100
LCMA35-10H-C	35	25	M10	8.2	15.5	12.3	8.5	36.7	100
LCMA35-12H-C	35	25	M12	8.2	21.5	14.5	11.5	42.1	100
LCMA50-6H-L	50	35	M6	9.8	18.0	11.5	10.0	40.1	50
LCMA50-8H-L	50	35	M8	9.8	18.0	11.5	10.0	40.1	50
LCMA50-10H-L	50	35	M10	9.8	18.0	11.5	10.0	40.1	50
LCMA50-12H-L	50	35	M12	9.8	23.0	14.0	11.0	43.1	50
LCMA70-6H-L	70	50	M6	11.5	20.8	14.5	11.5	46.8	50
LCMA70-8H-L	70	50	M8	11.5	20.8	14.5	11.5	46.8	50
LCMA70-10H-L	70	50	M10	11.5	20.8	14.5	11.5	46.8	50
LCMA70-12H-L	70	50	M12	11.5	20.8	14.5	11.5	46.7	50
LCMA95-8H-L	95	70	M8	13.5	24.5	15.0	13.5	52.6	50
LCMA95-10H-L	95	70	M10	13.5	24.5	15.0	13.5	52.6	50
LCMA95-12H-L	95	70	M12	13.5	24.5	15.0	13.5	52.6	50
LCMA95-16H-L	95	70	M16	13.5	24.5	15.0	13.5	52.5	50
LCMA120-8H-L	120	95	M8	15.2	27.5	15.5	14.5	56.6	50
LCMA120-10H-L	120	95	M10	15.2	27.5	15.5	14.5	56.6	50
LCMA120-12H-L	120	95	M12	15.2	27.5	15.5	14.5	56.6	50
LCMA120-16H-L	120	95	M16	15.2	27.5	15.5	14.5	56.6	50
LCMA150-8H-X	150	120	M8	16.5	30.5	18.0	16.5	64.7	10
LCMA150-10H-X	150	120	M10	16.5	30.5	18.0	16.5	64.7	10
LCMA150-12H-X	150	120	M12	16.5	30.5	18.0	16.5	64.7	10
LCMA150-16H-X	150	120	M16	16.5	30.5	18.0	16.5	64.6	10
LCMA150-20H-X	150	120	M20	16.5	30.5	22.0	16.5	68.3	10
LCMA185-10H-X	185	150	M10	18.6	33.5	16.5	17.5	66.0	10
LCMA185-12H-X	185	150	M12	18.6	33.5	16.5	17.5	66.0	10
LCMA185-16H-X	185	150	M16	18.6	33.5	16.5	17.5	66.0	10
LCMA185-20H-X	185	150	M20	18.6	33.5	21.0	17.5	70.5	10
LCMA240-10H-X	240	185	M10	20.8	37.5	21.0	19.5	79.3	10
LCMA240-12H-X	240	185	M12	20.8	37.5	21.0	19.5	79.3	10
LCMA240-16H-X	240	185	M16	20.8	37.5	21.0	19.5	79.3	10
LCMA240-20H-X	240	185	M20	20.8	37.5	21.0	19.5	79.3	10
LCMA300-10H-5	300	240	M10	23.5	42.5	22.0	20.0	85.5	5
LCMA300-12H-5	300	240	M12	23.5	42.5	22.0	20.0	82.5	5
LCMA300-16H-5	300	240	M16	23.5	42.5	22.0	20.0	85.5	5
LCMA300-20H-5	300	240	M20	23.5	42.5	22.0	20.0	85.4	5
LCMAX300-10H-5 <sup>^</sup>	–	300*	M10	26.2	48.0	26.5	23.5	98.4	5
LCMAX300-12H-5 <sup>^</sup>	–	300*	M12	26.2	48.0	26.5	23.5	98.4	5
LCMAX300-16H-5 <sup>^</sup>	–	300*	M16	26.2	48.0	26.5	23.5	98.4	5
LCMAX300-20H-5 <sup>^</sup>	–	300*	M20	26.2	48.0	26.5	23.5	98.4	5

See page 18 for tool and die information.

\*Class 5f conductor only.

\*\*Consult cable manufacturer for voltage stress relief instructions with applications greater than 2000 V.

<sup>^</sup>Not CE compliant and not tested to EN 61238-1:2003/IEC 61238-1:2003 for terminations with metric Class 5f or Class 6f flexible stranded conductor.

# Rigid and Flexible Stranded Metric Conductor, One-Hole, Standard Barrel with Window Lug, 90° Angle

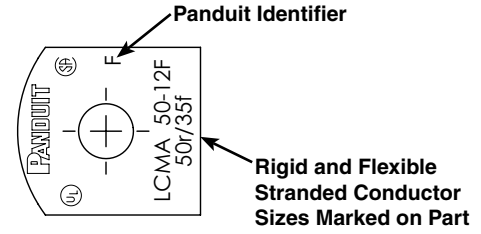
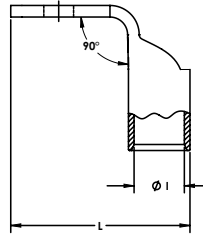
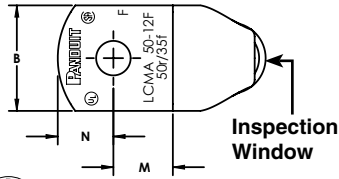

LISTED CERTIFIED To 35 KV\*\*  
 Rated to 90°C



and EN 61238-1:2003/IEC 61238-1:2003 Class B, sizes 10mm<sup>2</sup> – 240mm<sup>2</sup> Class 2r

Part Number	Copper Conductor Size (mm <sup>2</sup> )	Copper Conductor Size Class 5f/6f <sup>^</sup> (mm <sup>2</sup> )	Stud Hole Size (mm)	Figure Dimensions (mm)					Std. Pkg. Qty.
				ØI	B	M	N	L	
LCMA10-5F-C	10	—	M5	4.5	11.0	9.8	6.0	24.5	100
LCMA10-6F-C	10	—	M6	4.5	11.0	9.8	6.0	24.5	100
LCMA10-8F-C	10	—	M8	4.5	13.0	8.5	8.0	25.2	100
LCMA10-10F-C	10	—	M10	4.4	14.5	8.5	8.0	26.2	100
LCMA16-5F-C	16	10	M5	5.5	13.0	10.3	6.5	26.5	100
LCMA16-6F-C	16	10	M6	5.5	13.0	10.3	6.5	26.5	100
LCMA16-8F-C	16	10	M8	5.5	13.0	10.3	6.5	26.5	100
LCMA16-10F-C	16	10	M10	5.5	15.0	10.2	8.0	27.9	100
LCMA25-6F-C	25	16	M6	6.9	14.0	10.0	8.0	29.9	100
LCMA25-8F-C	25	16	M8	6.9	15.5	10.0	8.0	29.3	100
LCMA25-10F-C	25	16	M10	6.9	15.5	10.0	8.0	29.9	100
LCMA35-6F-C	35	25	M6	8.2	15.5	12.3	8.5	34.7	100
LCMA35-8F-C	35	25	M8	8.2	15.5	12.3	8.5	34.7	100
LCMA35-10F-C	35	25	M10	8.2	15.5	12.3	8.5	34.7	100
LCMA35-12F-C	35	25	M12	8.2	21.5	14.5	11.5	40.0	100
LCMA50-6F-L	50	35	M6	9.8	18.0	11.5	10.0	38.4	50
LCMA50-8F-L	50	35	M8	9.8	18.0	11.5	10.0	38.4	50
LCMA50-10F-L	50	35	M10	9.8	18.0	11.5	10.0	38.4	50
LCMA50-12F-L	50	35	M12	9.8	23.0	14.0	11.0	41.9	50
LCMA70-6F-L	70	50	M6	11.5	20.8	14.5	11.5	42.3	50
LCMA70-8F-L	70	50	M8	11.5	20.8	14.5	11.5	42.3	50
LCMA70-10F-L	70	50	M10	11.5	20.8	14.5	11.5	42.3	50
LCMA70-12F-L	70	50	M12	11.5	20.8	14.5	11.5	42.3	50
LCMA95-8F-L	95	70	M8	13.5	24.5	15.0	13.5	50.1	50
LCMA95-10F-L	95	70	M10	13.5	24.5	15.0	13.5	50.1	50
LCMA95-12F-L	95	70	M12	13.5	24.5	15.0	13.5	50.1	50
LCMA95-16F-L	95	70	M16	13.5	24.5	15.0	13.5	50.1	50
LCMA120-8F-L	120	95	M8	15.2	27.5	15.5	14.5	54.2	50
LCMA120-10F-L	120	95	M10	15.2	27.5	15.5	14.5	54.2	50
LCMA120-12F-L	120	95	M12	15.2	27.5	15.5	14.5	54.2	50
LCMA120-16F-L	120	95	M16	15.2	27.5	15.5	14.5	54.2	50
LCMA150-8F-X	150	120	M8	16.5	30.5	18.0	16.5	60.5	10
LCMA150-10F-X	150	120	M10	16.5	30.5	18.0	16.5	60.5	10
LCMA150-12F-X	150	120	M12	16.5	30.5	18.0	16.5	60.5	10
LCMA150-16F-X	150	120	M16	16.5	30.5	18.0	16.5	60.5	10
LCMA150-20F-X	150	120	M20	16.5	30.5	22.0	16.5	64.5	10
LCMA185-10F-X	185	150	M10	18.6	33.5	16.5	17.5	62.0	10
LCMA185-12F-X	185	150	M12	18.6	33.5	16.5	17.5	62.0	10
LCMA185-16F-X	185	150	M16	18.6	33.5	18.5	17.5	64.0	10
LCMA185-20F-X	185	150	M20	18.6	33.5	21.0	17.5	66.5	10
LCMA240-10F-X	240	185	M10	20.8	37.5	21.0	19.5	71.5	10
LCMA240-12F-X	240	185	M12	20.8	37.5	21.0	19.5	71.5	10
LCMA240-16F-X	240	185	M16	20.8	37.5	21.0	19.5	71.5	10
LCMA240-20F-X	240	185	M20	20.8	37.5	21.0	19.5	71.5	10

See page 18 for tool and die information.

\*Class 5f conductor only.

\*\*Consult cable manufacturer for voltage stress relief instructions with applications greater than 2000 V.

^Not CE compliant and not tested to EN 61238-1:2003/IEC 61238-1:2003 for terminations with metric Class 5f or Class 6f flexible stranded conductor.



# Rigid and Flexible Stranded Metric Conductor, One-Hole, Standard Barrel with Window Lug, 90° Angle (continued)



To 35 KV\*\*  
Rated to 90°C



and EN 61238-1:2003/IEC 61238-1:2003 Class B, sizes 10mm<sup>2</sup> – 240mm<sup>2</sup> Class 2r

Part Number	Copper Conductor Size Class 2r (mm <sup>2</sup> )	Copper Conductor Size Class 5f/6f <sup>^</sup> (mm <sup>2</sup> )	Stud Hole Size (mm)	Figure Dimensions (mm)					Std. Pkg. Qty.
				ØI	B	M	N	L	
LCMA300-10F-5	300	240	M10	23.5	42.5	22.0	20.0	77.3	5
LCMA300-12F-5	300	240	M12	23.5	42.5	22.0	20.0	77.3	5
LCMA300-16F-5	300	240	M16	23.5	42.5	22.0	20.0	77.3	5
LCMA300-20F-5	300	240	M20	23.5	42.5	22.0	20.0	77.3	5
LCMAX300-10F-5 <sup>^</sup>	—	300*	M10	26.2	48.0	26.5	23.5	88.0	5
LCMAX300-12F-5 <sup>^</sup>	—	300*	M12	26.2	48.0	26.5	23.5	88.0	5
LCMAX300-16F-5 <sup>^</sup>	—	300*	M16	26.2	48.0	26.5	23.5	88.0	5
LCMAX300-20F-5 <sup>^</sup>	—	300*	M20	26.2	48.0	26.5	23.5	88.0	5

See page 18 for tool and die information.

\*Class 5f conductor only.

\*\*Consult cable manufacturer for voltage stress relief instructions with applications greater than 2000 V.

<sup>^</sup>Not CE compliant and not tested to EN 61238-1:2003/IEC 61238-1:2003 for terminations with metric Class 5f or Class 6f flexible stranded conductor.

# Rigid and Flexible Stranded Metric Conductor, One-Hole, Long Barrel Lug, No Window

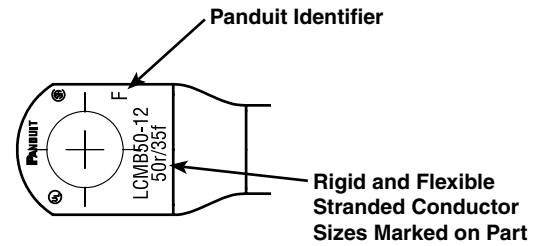
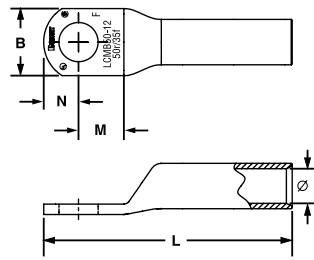

To 35 KV\*\*  
Rated to 90°C



and EN 61238-1:2003/IEC 61238-1:2003 Class B, sizes 10mm<sup>2</sup> – 240mm<sup>2</sup> Class 2r

Part Number	Copper Conductor Size Class 2r (mm <sup>2</sup> )	Copper Conductor Size Class 5f/6f <sup>^</sup> (mm <sup>2</sup> )	Stud Hole Size (mm)	Figure Dimensions (mm)					Std. Pkg. Qty.
				ØI	B	M	N	L	
LCMB10-5-L	10	—	M5	4.5	11.0	9.8	6.0	43.8	50
LCMB10-6-L	10	—	M6	4.5	11.0	9.8	6.0	43.8	50
LCMB10-8-L	10	—	M8	4.5	13.0	8.5	8.0	43.8	50
LCMB10-10-L	10	—	M10	4.4	14.5	8.5	8.0	43.8	50
LCMB16-5-L	16	10	M5	5.5	13.0	10.3	6.5	47.2	50
LCMB16-6-L	16	10	M6	5.5	13.0	10.3	6.5	47.2	50
LCMB16-8-L	16	10	M8	5.5	13.0	10.3	6.5	47.2	50
LCMB16-10-L	16	10	M10	5.5	15.0	10.2	8.0	49.4	50
LCMB25-6-L	25	16	M6	6.9	14.0	10.0	8.0	48.7	50
LCMB25-8-L	25	16	M8	6.9	15.5	10.0	8.0	48.7	50
LCMB25-10-L	25	16	M10	6.9	15.5	10.0	8.0	48.7	50
LCMB35-6-Q	35	25	M6	8.2	15.5	12.3	8.5	57.3	25
LCMB35-8-Q	35	25	M8	8.2	15.5	12.3	8.5	57.3	25
LCMB35-10-Q	35	25	M10	8.2	15.5	12.3	8.5	57.3	25
LCMB35-12-Q	35	25	M12	8.2	21.5	14.5	11.5	63.3	25
LCMB50-6-E	50	35	M6	9.8	18.0	11.5	10.0	62.8	20
LCMB50-8-E	50	35	M8	9.8	18.0	11.5	10.0	62.8	20
LCMB50-10-E	50	35	M10	9.8	18.0	11.5	10.0	62.8	20
LCMB50-12-E	50	35	M12	9.8	23.0	14.0	11.0	66.3	20
LCMB70-8-X	70	50	M8	11.5	20.8	14.5	11.5	68.2	10
LCMB70-10-X	70	50	M10	11.5	20.8	14.5	11.5	68.2	10
LCMB70-12-X	70	50	M12	11.5	20.8	14.5	11.5	68.2	10

See page 19 for tool and die information.

\*Class 5f conductor only.

\*\*Consult cable manufacturer for voltage stress relief instructions with applications greater than 2000 V.

<sup>^</sup>Not CE compliant and not tested to EN 61238-1:2003/IEC 61238-1:2003 for terminations with metric Class 5f or Class 6f flexible stranded conductor.

# Rigid and Flexible Stranded Metric Conductor, One-Hole, Long Barrel Lug, No Window (continued)



To 35 KV\*\*  
Rated to 90°C



and EN 61238-1:2003/IEC 61238-1:2003 Class B, sizes 10mm<sup>2</sup> – 240mm<sup>2</sup> Class 2r

Part Number	Copper Conductor Size Class 2r (mm <sup>2</sup> )	Copper Conductor Size Class 5f/6f <sup>^</sup> (mm <sup>2</sup> )	Stud Hole Size (mm)	Figure Dimensions (mm)					Std. Pkg. Qty.
				ØI	B	M	N	L	
LCMB95-8-X	95	70	M8	13.5	24.5	15.0	13.5	79.0	10
LCMB95-10-X	95	70	M10	13.5	24.5	15.0	13.5	79.0	10
LCMB95-12-X	95	70	M12	13.5	24.5	15.0	13.5	79.0	10
LCMB95-16-X	95	70	M16	13.5	24.5	15.0	13.5	79.0	10
LCMB120-8-X	120	95	M8	15.2	27.5	15.5	14.5	80.2	10
LCMB120-10-X	120	95	M10	15.2	27.5	15.5	14.5	80.2	10
LCMB120-12-X	120	95	M12	15.2	27.5	15.5	14.5	80.2	10
LCMB120-16-X	120	95	M16	15.2	27.5	15.5	14.5	80.2	10
LCMB150-8-X	150	120	M8	16.5	30.5	18.0	16.5	100.0	10
LCMB150-10-X	150	120	M10	16.5	30.5	18.0	16.5	100.0	10
LCMB150-12-X	150	120	M12	16.5	30.5	18.0	16.5	100.0	10
LCMB150-16-X	150	120	M16	16.5	30.5	18.0	16.5	100.0	10
LCMB150-20-X	150	120	M20	16.5	30.5	22.0	16.5	103.5	10
LCMB185-10-X	185	150	M10	18.6	33.5	16.5	17.5	100.6	10
LCMB185-12-X	185	150	M12	18.6	33.5	16.5	17.5	100.6	10
LCMB185-16-X	185	150	M16	18.6	33.5	16.5	17.5	100.6	10
LCMB185-20-X	185	150	M20	18.6	33.5	21.0	17.5	105.1	10
LCMB240-10-6	240	185	M10	20.8	37.5	21.0	19.5	115.0	6
LCMB240-12-6	240	185	M12	20.8	37.5	21.0	19.5	115.0	6
LCMB240-16-6	240	185	M16	20.8	37.5	21.0	19.5	115.0	6
LCMB240-20-6	240	185	M20	20.8	37.5	21.0	19.5	115.0	6
LCMB300-10-6	300	240	M10	23.5	42.5	22.0	20.0	122.6	6
LCMB300-12-6	300	240	M12	23.5	42.5	22.0	20.0	122.6	6
LCMB300-16-6	300	240	M16	23.5	42.5	22.0	20.0	122.6	6
LCMB300-20-6	300	240	M20	23.5	42.5	22.0	20.0	122.6	6
LCMBX300-10-6 <sup>^</sup>	—	300*	M10	26.2	48.0	26.5	23.5	135.2	6
LCMBX300-12-6 <sup>^</sup>	—	300*	M12	26.2	48.0	26.5	23.5	135.2	6
LCMBX300-16-6 <sup>^</sup>	—	300*	M16	26.2	48.0	26.5	23.5	135.2	6
LCMBX300-20-6 <sup>^</sup>	—	300*	M20	26.2	48.0	26.5	23.5	135.2	6
LCMB400-12-6	400	—	M12	27.0	49.5	26.5	23.5	127.4	6
LCMB400-16-6	400	—	M16	27.0	49.5	26.5	23.5	127.4	6
LCMB400-20-6	400	—	M20	27.0	49.5	26.5	23.5	127.4	6
LCMB500-12-3	500	—	M12	31.0	57.5	28.5	25.5	149.7	3
LCMB500-16-3	500	—	M16	31.0	57.5	28.5	25.5	149.7	3
LCMB500-20-3	500	—	M20	31.0	57.5	28.5	25.5	149.7	3
LCMB630-16-3	630	—	M16	34.5	63.0	28.5	27.5	159.1	3
LCMB630-20-3	630	—	M20	34.5	63.0	28.5	27.5	159.1	3

See page 19 for tool and die information.

\*Class 5f conductor only.

\*\*Consult cable manufacturer for voltage stress relief instructions with applications greater than 2000 V.

<sup>^</sup>Not CE compliant and not tested to EN 61238-1:2003/IEC 61238-1:2003 for terminations with metric Class 5f or Class 6f flexible stranded conductor.

# Rigid and Flexible Stranded Metric Conductor, Two-Hole, Long Barrel Lug, No Window



To 35 KV\*\*  
Rated to 90°C



and EN 61238-1:2003/IEC 61238-1:2003 Class B, sizes 10mm<sup>2</sup> – 630mm<sup>2</sup> Class 2r

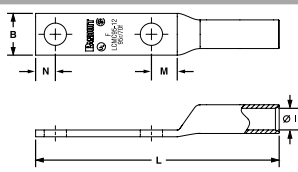

Figure 1.  
Two-Hole

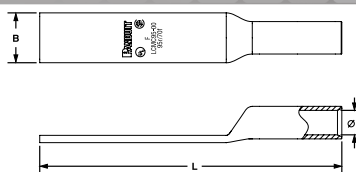
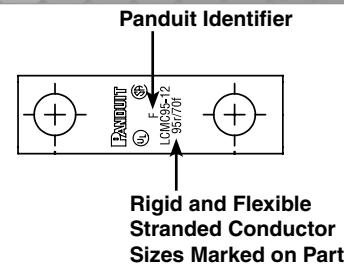

Figure 2.  
Blank Tongue



Part Number	Figure No.	Copper Conductor Size Class 2r (mm <sup>2</sup> )	Copper Conductor Size Class 5f/6f <sup>^</sup> (mm <sup>2</sup> )	Stud Hole Size (mm)	Stud Hole Spacing (mm)	Figure Dimensions (mm)					Std. Pkg. Qty.
						Ø1	B	M	N	L	
LCMC10-00-L	2	10	—	Blank	—	4.4	14.5	—	—	87.8	50
LCMC10-8-L	1	10	—	M8	44.5	4.5	13.0	8.5	8.0	87.8	50
LCMC16-00-L	2	16	10	Blank	—	5.5	15.0	—	—	93.9	50
LCMC16-8-L	1	16	10	M8	44.5	5.5	13.0	10.3	6.5	91.7	50
LCMC25-00-L	2	25	16	Blank	—	7.1	20.0	—	—	101.2	50
LCMC25-8-L	1	25	16	M8	44.5	6.9	15.5	10.0	8.0	93.2	50
LCMC25-10-L	1	25	16	M10	44.5	6.9	15.5	10.0	8.0	93.2	50
LCMC25-12-L	1	25	16	M12	44.5	7.1	20.0	14.5	11.5	101.2	50
LCMC35-00-Q	2	35	25	Blank	—	8.2	21.5	—	—	107.8	25
LCMC35-10-Q	1	35	25	M10	44.5	8.2	15.5	12.3	8.5	101.8	25
LCMC35-12-Q	1	35	25	M12	44.5	8.2	21.5	14.5	11.5	107.8	25
LCMC50-00-E	2	50	35	Blank	—	9.8	23.0	—	—	110.8	20
LCMC50-10-E	1	50	35	M10	44.5	9.8	18.0	11.5	10.0	107.3	20
LCMC50-12-E	1	50	35	M12	44.5	9.8	23.0	14.0	11.0	110.8	20
LCMC70-00-X	2	70	50	Blank	—	11.5	20.8	—	—	112.7	10
LCMC70-10-X	1	70	50	M10	44.5	11.5	20.8	14.5	11.5	112.7	10
LCMC70-12-X	1	70	50	M12	44.5	11.5	20.8	14.5	11.5	112.7	10
LCMC95-00-X	2	95	70	Blank	—	13.5	24.5	—	—	123.5	10
LCMC95-12-X	1	95	70	M12	44.5	13.5	24.5	15.0	13.5	123.5	10
LCMC95-14-X	1	95	70	M14	44.5	13.5	24.5	15.0	13.5	123.5	10
LCMC120-00-X	2	120	95	Blank	—	15.2	27.5	—	—	124.7	10
LCMC120-12-X	1	120	95	M12	44.5	15.2	27.5	15.5	14.5	124.7	10
LCMC120-14-X	1	120	95	M14	44.5	15.2	27.5	15.5	14.5	124.7	10
LCMC150-00-X	2	150	120	Blank	—	16.5	30.5	—	—	148.0	10
LCMC150-12-X	1	150	120	M12	44.5	16.5	30.5	18.0	16.5	144.5	10
LCMC150-14-X	1	150	120	M14	44.5	16.5	30.5	22.0	16.5	148.0	10
LCMC185-00-X	2	185	150	Blank	—	18.6	33.5	—	—	149.6	10
LCMC185-12-X	1	185	150	M12	44.5	18.6	33.5	16.5	17.5	145.1	10
LCMC185-14-X	1	185	150	M14	44.5	18.6	33.5	21.0	17.5	149.6	10
LCMC240-00-6	2	240	185	Blank	—	20.8	37.5	—	—	159.5	6
LCMC240-12-6	1	240	185	M12	44.5	20.8	37.5	21.0	19.5	159.5	6
LCMC240-14-6	1	240	185	M14	44.5	20.8	37.5	21.0	19.5	159.5	6
LCMC300-00-6	2	300	240	Blank	—	23.5	42.5	—	—	167.1	6
LCMC300-12-6	1	300	240	M12	44.5	23.5	42.5	22.0	20.0	167.1	6
LCMC300-14-6	1	300	240	M14	44.5	23.5	42.5	22.0	20.0	167.1	6
LCMCX300-00-6 <sup>^</sup>	2	—	300*	Blank	—	26.2	48.0	—	—	179.7	6
LCMCX300-12-6 <sup>^</sup>	1	—	300*	M12	44.5	26.2	48.0	26.5	23.5	179.7	6
LCMCX300-14-6 <sup>^</sup>	1	—	300*	M14	44.5	26.2	48.0	26.5	23.5	179.7	6
LCMC400-00-6	2	400	—	Blank	—	27.0	49.5	—	—	171.9	6
LCMC400-12-6	1	400	—	M12	44.5	27.0	49.5	26.5	23.5	171.9	6
LCMC400-14-6	1	400	—	M14	44.5	27.0	49.5	26.5	23.5	171.9	6
LCMC400-16-6	1	400	—	M16	44.5	27.0	49.5	26.5	23.5	171.9	6
LCMC500-00-3	2	500	—	Blank	—	31.0	57.5	—	—	194.2	3
LCMC500-12-3	1	500	—	M12	44.5	31.0	57.5	28.5	25.5	194.2	3
LCMC500-14-3	1	500	—	M14	44.5	31.0	57.5	28.5	25.5	194.2	3
LCMC500-16-3	1	500	—	M16	44.5	31.0	57.5	28.5	25.5	194.2	3
LCMC630-00-3	2	630	—	Blank	—	34.5	63.0	—	—	203.6	3
LCMC630-12-3	1	630	—	M12	44.5	34.5	63.0	28.5	27.5	203.6	3
LCMC630-14-3	1	630	—	M14	44.5	34.5	63.0	28.5	27.5	203.6	3
LCMC630-16-3	1	630	—	M16	44.5	34.5	63.0	28.5	27.5	203.6	3

See page 19 for tool and die information.

\*Class 5f conductor only.

\*\*Consult cable manufacturer for voltage stress relief instructions with applications greater than 2000 V.

<sup>^</sup>Not CE compliant and not tested to EN 61238-1:2003/IEC 61238-1:2003 for terminations with metric Class 5f or Class 6f flexible stranded conductor.

# Agency Approved Terminations with Copper Class 2r Rigid Stranded Metric Conductors

Panduit termination system for stranded metric conductors ensures safety and reliability by meeting these Standards:

- UL 486A-486B Wire Connectors and Soldering Lugs
- CSA C22.2 No. 65-03 Wire Connectors
- EN 61238-1:2003/IEC 61238-1:2003 Class B (4mm<sup>2</sup> – 630mm<sup>2</sup>)

## Steps to Achieve



### Example: Circumferential Crimp Die System

#### 1. Components



Panduit Connector

+



Copper Class 2r Rigid Stranded Metric Conductor

+



Panduit Dies

+



Panduit Tool

#### 2. Crimped Connection



Applying Crimp



Crimped Lug Top View



Die Index Numbers

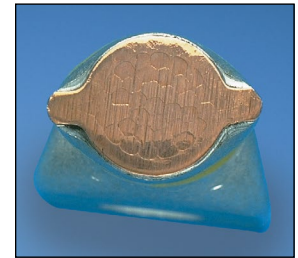

Crimped Lug Cross Section

#### 3. Static Heating Sequence

##### Wire Secureness Test

Long-term dependability in applications with moving equipment

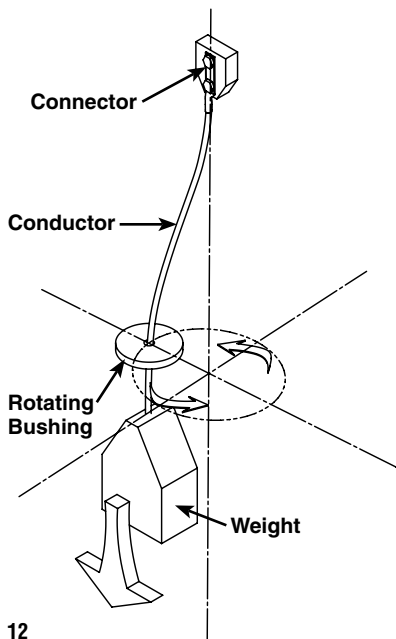

##### Static Heating Test

Safe connection at rated current

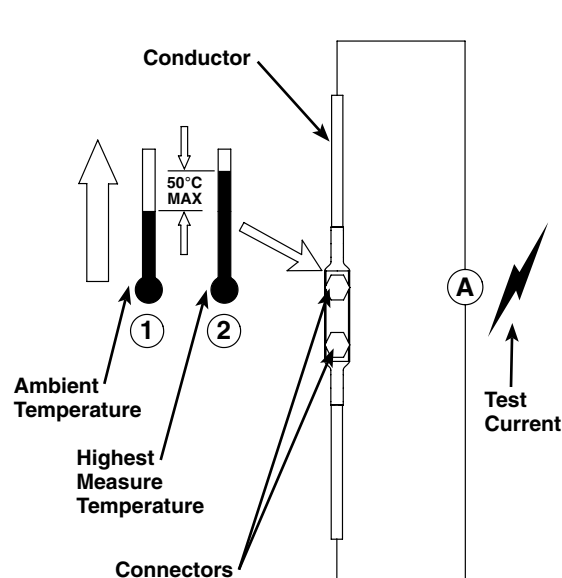

##### Wire Pullout Test

Secure connection under static tensile loads

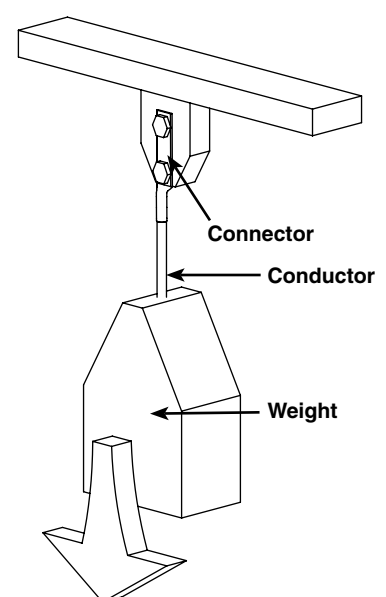

# Agency Approved Terminations with Copper Class 5f and 6f Flexible Stranded Metric Conductors

Panduit termination system for flexible metric conductors ensures safety and reliability by meeting these Standards:

- UL 486A-486B Wire Connectors and Soldering Lugs
- CSA C22.2 No. 65-03 Wire Connectors

## Steps to Achieve



### Example: Nest/Indenter Die System

(Refer to page 14 for example of Circumferential Crimp Die System)

## 1. Components

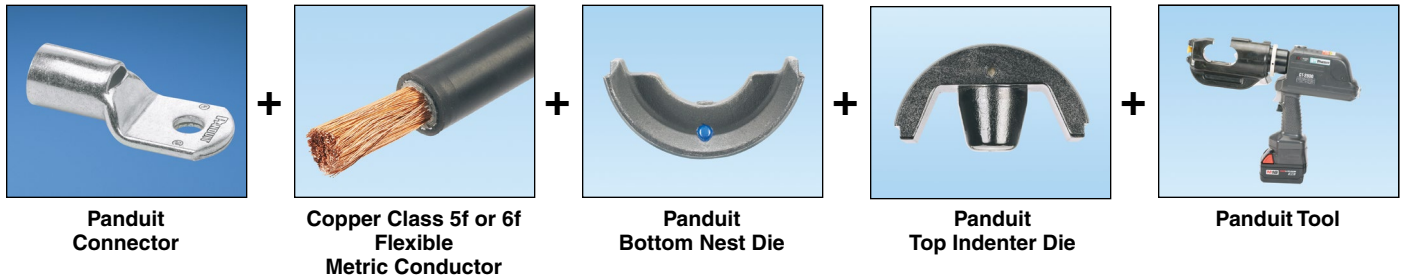

## 2. Crimped Connection



## 3. Static Heating Sequence

### Wire Secureness Test

Long-term dependability in applications with moving equipment

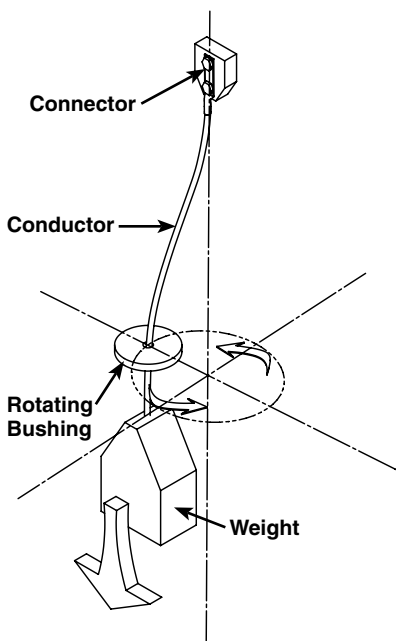

### Static Heating Test

Safe connection at rated current

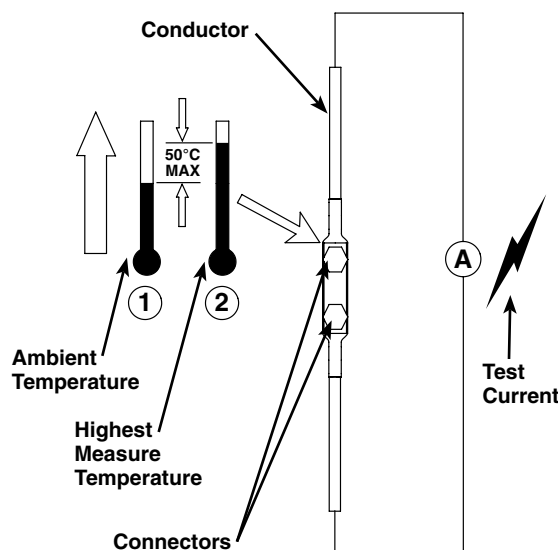

### Wire Pullout Test

Secure connection under static tensile loads

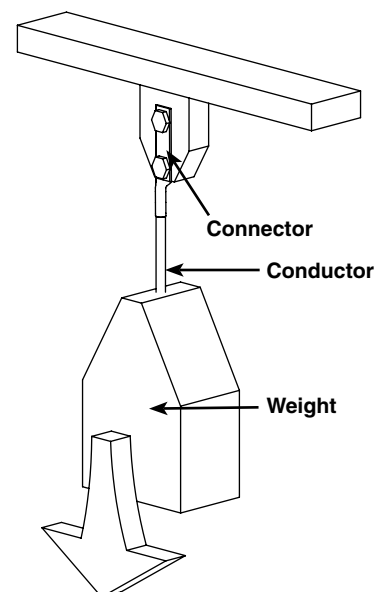

# Tool and Die Selection Chart for Standard Barrel Straight Metric Lugs and Splices with Copper Class 2r Conductor

Panduit Part Number	Copper Conductor Size Class 2r <sup>^</sup> (mm <sup>2</sup> )	Wire Strip Length (mm)						
			Die Part Number Color Code and Index Number (Number of Crimps)					
LCMA6 LCMD6	4-6	11.0 11.0	22-10 (1)	12-10 (1)	CT-570CH 12-10 (1)	P10 (1)	—	—
LCMA10 LCMD10 SCMS10	10	12.5 12.5 16.5	—	—	—	—	CD-2001-8 Red P21 (1)	CD-920-8 Red P21 (1)
LCMA16 LCMD16 SCMS16	16	16.0 16.0 19.0	—	—	—	—	CD-2001-6 Blue P24 (1)	CD-920-6 Blue P24 (1)
LCMA25 LCMD25 SCMS25	25	16.5 16.5 19.5	—	—	—	—	CD-2001-4 Gray P29 (1)	CD-920-4 Gray P29 (1)
LCMA35 LCMD35 SCMS35	35	19.0 19.0 19.5	—	—	—	—	CD-2001-4 Gray P29 (1)	CD-920-4 Gray P29 (1)
LCMA50 LCMD50 SCMS50	50	21.8 21.8 26.0	—	—	—	—	CD-2001-1 Green P37 (1)	CD-920-1 Green P37 (1)
LCMA70 LCMD70 SCMS70	70	24.8 24.8 27.5	—	—	—	—	CD-2001-2/0 Black P45 (2)	CD-920-2/0 Black P45 (2)
LCMA95 LCMD95 SCMS95	95	26.0 26.0 28.5	—	—	—	—	CD-2001-4/0 Purple P54 (2)	CD-920-4/0 Purple P54 (2)
LCMA120 LCMD120 SCMS120	120	26.0 26.0 30.0	—	—	—	—	CD-2001-250 Yellow P62 (2)	CD-920-250 Yellow P62 (2)
LCMA150 LCMD150 SCMS150	150	29.0 29.0 30.0	—	—	—	—	CD-2001-300 White P66 (2)	CD-920-300 White P66 (2)
LCMA185 LCMD185 SCMS185	185	29.7 29.7 32.0	—	—	—	—	CD-2001-400 Blue P76 (2)	CD-920-400 Blue P76 (2)
LCMA240 LCMD240 SCMS240	240	36.5 36.5 37.5	—	—	—	—	CD-2001-500 Brown P87 (2)	CD-920-500 Brown P87 (2)
LCMA300 LCMD300 SCMS300	300	41.8 41.8 39.0	—	—	—	—	—	CD-920-600 Green P94 (2)
LCMA400 LCMD400 SCMS400	400	46.3 46.3 49.0	—	—	—	—	—	CD-920-750 CD-940-750** Black P106 (2)
LCMA500 LCMD500 SCMS500	500	48.0 48.0 49.5	—	—	—	—	—	CD-940-1000** White P125 (3)
LCMA630 LCMD630 SCMS630	630	57.7 57.7 67.0	—	—	—	—	—	CD-940-1000** White P125 (4)

\*CD-920 dies can be used with the CT-940CH and CT-2940 tools with the CD-940-DA adapter.

\*\*CD-940 dies to be used exclusively with CT-940CH and CT-2940 tools.

<sup>^</sup>Class 2r Rigid Stranded Metric Copper Conductor Per DIN VDE 0295, IEC 60228 and HD 383.

‡CE Approved crimp tool.

**How to read this chart**  
For LCMA630 lug and  
CT-2940/L crimping tool:



### CST114-157 Ergonomic Wire Stripper

- Provides circular, spiral, and in-line insulation cutting without knives to reduce injuries
- For wires 3/16" (4.76mm) to 1 9/16" (39.7mm) diameter

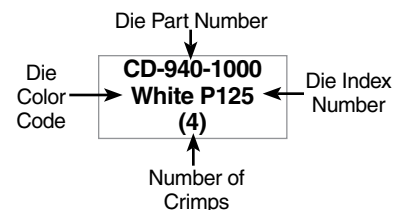

# Tool and Die Selection Chart for Standard Barrel Straight Metric Lugs and Splices with Copper Class 5f and 6f Conductors

Panduit Part Number	Copper Conductor Size (mm <sup>2</sup> )	Conductor Class <sup>^</sup>	Wire Strip Length (mm)					 CT-2001, CT-2002, CT-3001, CT-3001/E‡	 CT-2931, CT-930, CT-2930CH, CT-2930, CT-2930/L, CT-2930/LE‡, CT-940CH**, CT-2940**, CT-2940/L**, CT-2940/LE**‡		
				Pocket Number (Number of Crimps)					Die Part Number Color Code and Index Number (Number of Crimps)	Bottom Nest Die‡‡ Part Number Color Code, Index Number	Top Indenter Die Part Number Index Number
LCMAX6 LCMDX6	4-6	Class 5f	11.0 11.0	22-10 (2)	12-10 (2)	CT-570 12-10 (2)	P10 (2)	—	—	—	—
LCMAX10 LCMDX10 SCMSX10	10	Class 5f Class 6f	16.0 16.0 19.0	—	—	—	—	CD-2001-8 Red P21 (1)	CD-920-4NEST Gray P29	CDI-920-10 1	(1)
LCMAX16 LCMDX16	16	Class 5f Class 6f	16.5 16.5	—	—	—	—	CD-2001-8 Red P21 (1)	CD-920-4NEST Gray P29	CDI-920-10 1	(1)
SCMSX16			26.0					CD-2001-8 Red P21 (2)			(1)
LCMAX25 LCMDX25 SCMSX25	25	Class 5f Class 6f	19.0 19.0 19.5	—	—	—	—	CD-2001-4 Gray P29 (1)	CD-920-1/0NEST Pink P42	CDI-920-24 2	(1)
LCMAX35 LCMDX35 SCMSX35	35	Class 5f Class 6f	21.8 21.8 26.0	—	—	—	—	CD-2001-2 Brown P33 (2)	CD-920-3/0NEST Orange P50	CDI-920-24 2	(1)
LCMAX50 LCMDX50 SCMSX50	50	Class 5f Class 6f	24.8 24.8 30.0	—	—	—	—	CD-2001-1 Green P37 (2)	CD-920-3/0NEST Orange P50	CDI-920-24 2	(1)
LCMAX70 LCMDX70 SCMSX70	70	Class 5f Class 6f	26.0 26.0 28.5	—	—	—	—	CD-2001-2/0 Black P45 (2)	CD-920-250NEST Yellow P62	CDI-920-48 4	(1)
LCMAX95 LCMDX95	95	Class 5f Class 6f	26.0 26.0	—	—	—	—	CD-2001-3/0 Orange P50 (2)	CD-920-400NEST Blue P76	CDI-920-48 4	(1)
SCMSX95			30.0					CD-2001-3/0 Orange P50 (3)			(1)
LCMAX120 LCMDX120 SCMSX120	120	Class 5f Class 6f	29.0 29.0 30.0	—	—	—	—	—	CD-920-400NEST Blue P76	CDI-920-48 4	(1)
LCMAX150 LCMDX150 SCMSX150	150	Class 5f Class 6f	29.7 29.7 32.0	—	—	—	—	—	CD-920-400NEST Blue P76	CDI-920-48 4	(1)
LCMAX185 LCMDX185 SCMSX185	185	Class 5f Class 6f	36.5 36.5 37.5	—	—	—	—	—	CD-920-500NEST Brown P87	CDI-920-48 4	(1)
LCMAX240 LCMDX240 SCMSX240	240	Class 5f Class 6f	41.8 41.8 49.0	—	—	—	—	—	CD-920-750NEST Black P106	CDI-920-60 6	(1)
LCMAX300 LCMDX300 SCMSX300	300	Class 5f	46.3 46.3 49.0	—	—	—	—	—	CD-920-300MXNST P32	CDI-920-60 6	(1)

\*\*CD-920 and CDI-920 dies can be used with CT-940CH and CT-2940 tools with CD-940-DA adapter.

<sup>^</sup>Class 5f and 6f Flexible Stranded Metric Copper Conductor Per DIN VDE 0295, IEC 60228 and HD 383.

‡CE Approved crimp tool.

‡‡Nest die must be used in conjunction with specified indenter die.

# Tool and Die Selection Chart for Standard Barrel 45° and 90° Bent Palm Metric Lugs with Copper Class 2r, 5f and 6f Conductor

Panduit Part Number	Wire Strip Length (mm)	Copper Conductor Size (mm <sup>2</sup> ) and Class <sup>^</sup>	Crimp Tools and Dies for Rigid Stranded Class 2r Conductor		Crimp Tools and Dies for Flexible Stranded Class 5f/6f Conductor					
			Die Part Number Color Code and Index Number (Number of Crimps)	Die Part Number Color Code and Index Number (Number of Crimps)	Copper Conductor Size (mm <sup>2</sup> ) and Class <sup>^</sup>	Die Part Number Color Code and Index Number (Number of Crimps)	Bottom Nest Die <sup>‡‡</sup> Part Number Color Code and Index Number	Top Indenter Die Part Number Index Number	Crimps Per Connector Nest/ Indenter Dies	
LCMA6 LCMD6	11.0	4-6 Class 2r	—	—	4-6 Class 5f	—	—	—	—	—
LCMA10 LCMD10 SCMS10	12.5	10 Class 2r	CD-2001-8 Red P21 (1)	CD-920-8 Red P21 (1)	—	—	—	—	—	—
LCMA16 LCMD16 SCMS16	16	16 Class 2r	CD-2001-8 Red P21 (1)	CD-920-8 Red P21 (1)	10 Class 5f Class 6f	CD-920-8 Red P21 (1)	CD-920-8 Red P21 (1)	CD-920-4NEST Gray P29	CDI-920-10 1	(1)
LCMA25 LCMD25 SCMS25	16.5	25 Class 2r	CD-2001-4 Gray P29 (1)	CD-920-4 Gray P29 (1)	16 Class 5f Class 6f	CD-920-8 Red P21 (1)	CD-920-8 Red P21 (1)	CD-920-4NEST Gray P29	CDI-920-10 1	(1)
LCMA35 LCMD35 SCMS35	19.0	35 Class 2r	CD-2001-4 Gray P29 (1)	CD-920-4 Gray P29 (1)	25 Class 5f Class 6f	CD-2001-4 Gray P29 (1)	CD-920-4 Gray P29 (1)	CD-920-1/0NEST Pink P42	CDI-920-24 2	(1)
LCMA50 LCMD50 SCMS50	21.8	50 Class 2r	CD-2001-1 Green P37 (1)	CD-2001-1 Green P37 (1)	35 Class 5f Class 6f	CD-2001-2 Brown P33 (2)	CD-920-2 Brown P33 (2)	CD-920-3/0NEST Orange P50	CDI-920-24 2	(1)
LCMA70 LCMD70 SCMS70	24.8	70 Class 2r	CD-2001-2/0 Black P45 (2)	CD-2001-2/0 Black P45 (2)	50 Class 5f Class 6f	CD-2001-1 Green P37 (2)	CD-920-1 Green P37 (2)	CD-920-3/0NEST Orange P50	CDI-920-24 2	(1)
LCMA95 LCMD95 SCMS95	26.0	95 Class 2r	CD-2001-4/0 Purple P54 (2)	CD-920-4/0 Purple P54 (2)	70 Class 5f Class 6f	CD-2001-2/0 Black P45 (2)	CD-920-2/0 Black P45 (2)	CD-920-25NEST Yellow P62	CDI-920-48 4	(1)
LCMA120 LCMD120 SCMS120	26.0	120 Class 2r	CD-2001-250 Yellow P62 (2)	CD-920-500 Yellow P62 (2)	95 Class 5f Class 6f	CD-2001-3/0 Orange P50 (2)	CD-920-3/0 Orange P50 (2)	CD-920-400NEST Blue P76	CDI-920-48 4	(1)
LCMA150 LCMD150 SCMS150F	29.0	150 Class 2r	CD-2001-300 White P66 (2)	CD-920-300 White P66 (2)	120 Class 5f Class 6f	—	—	CD-920-400NEST Blue P76	CDI-920-48 4	(1)
LCMA185 LCMD185 SCMS185	36.5	185 Class 2r	CD-2001-400 Blue P76 (2)	CD-920-400 Blue P76 (2)	150 Class 5f Class 6f	—	—	CD-920-400NEST Blue P76	CDI-920-48 4	(1)
LCMA240 LCMD240 SCMS240	41.8	240 Class 2r	CD-2001-500 Brown P87 (2)	CD-920-500 Brown P87 (2)	185 Class 5f Class 6f	—	—	CD-920-500NEST Brown P87	CDI-920-48 4	(1)
LCMA300 LCMD300 SCMS300	46.3	300 Class 2r	—	CD-920-600 Green P94 (2)	240 Class 5f Class 6f	—	—	CD-920-750NEST Black P106	CDI-920-60 6	(1)
LCMAX300 LCMDX300 SCMSX300	46.3	—	—	—	300 Class 5f	—	—	CD-920-300MXNST P32	CDI-920-60 6	(1)
LCMA400 LCMD400 SCMS400	46.3 46.3 49.0	400 Class 2r	—	CD-920-750 CD-940-750** Black P106 (2)	—	—	—	—	—	—
LCMA500 LCMD500 SCMS500	48.0 48.0 49.5	500 Class 2r	—	CD-940-1000** White P125 (3)	—	—	—	—	—	—
LCMA630 LCMD630 SCMS630	57.7 57.7 67.0	630 Class 2r	—	CD-940-1000** White P125 (4)	—	—	—	—	—	—

\*CD-920 and CDI-920 dies can be used with CT-940CH and CT-2940 tools with CD-940-DA die adapter.

<sup>^</sup>Class 2r Rigid Stranded Metric Copper Conductor and Class 5f and 6f Flexible Stranded Metric Copper Conductor Per DIN VDE 0295, IEC 60228 and HD 383.

<sup>‡</sup>CE Approved crimp tool.

<sup>‡‡</sup>Nest die must be used in conjunction with specified indenter die.



# Tool and Die Selection Chart for Long Barrel Straight Metric Lugs with Copper Class 2r, 5f and 6f Conductor

Panduit Part Number	Wire Strip Length (mm)	Copper Conductor Size (mm <sup>2</sup> ) and Class <sup>^</sup>	Crimp Tools and Dies for Rigid Stranded Conductor		Crimp Tools and Dies for Flexible Stranded Conductor					
			Die Part Number Color Code and Index Number (Number of Crimps)	Die Part Number Color Code and Index Number (Number of Crimps)	Die Part Number Color Code and Index Number (Number of Crimps)	Bottom Nest Die <sup>‡‡</sup> Part Number Color Code, Index Number	Top Indenter Die Part Number Index Number	Crimps Per Connector Nest/ Indenter Dies		
LCMB10 LCMC10	25.6	10 Class 2r	CD-2001-8 Red P21 (2)	CD-920-8 Red P21 (2)	—	—	—	—	—	
LCMB16 LCMC16	28.8	16 Class 2r	CD-2001-8 Red P21 (2)	CD-920-8 Red P21 (2)	10mm <sup>2</sup> Class 5f Class 6f	CD-2001-8 Red P21 (2)	CD-920-8 Red P21 (2)	—	—	
LCMB25 LCMC25	28.3	25 Class 2r	CD-2001-4 Gray P29 (2)	CD-920-4 Gray P29 (2)	16mm <sup>2</sup> Class 5f Class 6f	CD-2001-8 Red P21 (2)	CD-920-8 Red P21 (2)	—	—	
LCMB35 LCMC35	34.4	35 Class 2r	CD-2001-4 Gray P29 (2)	CD-920-4 Gray P29 (2)	25mm <sup>2</sup> Class 5f Class 6f	CD-2001-4 Gray P29 (2)	CD-920-4 Gray P29 (2)	—	—	
LCMB50 LCMC50	38.2	50 Class 2r	CD-2001-1 Green P37 (2)	CD-920-1 Green P37 (2)	35mm <sup>2</sup> Class 5f Class 6f	CD-2001-2 Brown P33 (3)	CD-920-2 Brown P33 (3)	—	—	
LCMB70 LCMC70	39.6	70 Class 2r	CD-2001-2/0 Black P45 (3)	CD-920-2/0 Black P45 (3)	50mm <sup>2</sup> Class 5f Class 6f	CD-2001-1 Green P37 (3)	CD-920-1 Green P37 (3)	—	—	
LCMB95 LCMC95	44.6	95 Class 2r	CD-2001-4/0 Purple P54 (3)	CD-920-4/0 Purple P54 (3)	70mm <sup>2</sup> Class 5f Class 6f	CD-2001-2/0 Black P45 (3)	CD-920-2/0 Black P45 (3)	CD-920-250NEST Yellow P62	CDI-920-48 4	(2)
LCMB120 LCMC120	41.3	120 Class 2r	CD-2001-250 Yellow P62 (3)	CD-920-250 Yellow P62 (3)	95mm <sup>2</sup> Class 5f Class 6f	CD-2001-3/0 Orange P50 (3)	CD-920-3/0 Orange P50 (3)	CD-920-400NEST Blue P76	CDI-920-48 4	(2)
LCMB150 LCMC150	58.6	150 Class 2r	CD-2001-300 White P66 (3)	CD-920-300 White P66 (3)	120mm <sup>2</sup> Class 5f Class 6f	—	—	CD-920-400NEST Blue P76	CDI-920-48 4	(2)
LCMB185 LCMC185	57.9	185 Class 2r	CD-2001-400 Blue P76 (3)	CD-920-400 Blue P76 (3)	150mm <sup>2</sup> Class 5f Class 6f	—	—	CD-920-400NEST Blue P76	CDI-920-48 4	(2)
LCMB240 LCMC240	65.1	240 Class 2r	CD-2001-500 Brown P87 (3)	CD-920-500 Brown P87 (3)	185mm <sup>2</sup> Class 5f Class 6f	—	—	CD-920-500NEST Brown P87	CDI-920-48 4	(2)
LCMB300 LCMC300	70.0	300 Class 2r	—	CD-920-600 Green P94 (3)	240mm <sup>2</sup> Class 5f Class 6f	—	—	CD-920-750NEST Black P106	CDI-920-60 6	(2)
LCMBX300 LCMCX300	74.6	—	—	—	300mm <sup>2</sup> Class 5f	—	—	CD-920-300MXNST P32	CDI-920-60 6	(2)
LCMB400 LCMC400	66.8	400 Class 2r	—	CD-920-750 CD-940-750** Black P106 (3)	—	—	—	—	—	—
LCMB500 LCMC500	77.8	500 Class 2r	—	CD-940-1000** White P125 (4)	—	—	—	—	—	—
LCMB630 LCMC630	85.9	630 Class 2r	—	CD-940-1000** White P125 (5)	1000 kcmil Class G	—	CD-940-750A** Red P125 (2) CD-940-1000** White P125 (3)	—	—	—

\*CD-920 and CDI-920 dies can be used with CT-940CH and CT-2940 tools with CD-940-DA die adapter.

\*\*CD-940 dies to be used exclusively with CT-940CH and CT-2940 tools.

<sup>^</sup>Class 2r Rigid Stranded Metric Copper Conductor and Class 5f and 6f Flexible Stranded Metric Copper Conductor Per DIN VDE 0295, IEC 60228 and HD 383.

<sup>‡</sup>CE Approved crimp tool.

<sup>‡‡</sup>Nest die must be used in conjunction with specified indenter die.

# Complete Solutions from Panduit

Panduit's lithium-ion battery powered, hydraulic crimping tools provide more crimps per charge and a faster crimp cycle to significantly improve productivity and save labor cost.



**CT-3001/E In-Line Crimping Tool**

- 54 Kn (6 ton) output
- Provided with two Milwaukee® M18™ XC high capacity RED lithium-ion 18VDC rechargeable batteries, one Milwaukee® 230 VAC battery charger, and heavy-duty bag



**CT-2930/LE Crimping Tool**

- 124.5 Kn (14 ton) output
- Provided with two Milwaukee® M18™ XC high capacity RED lithium-ion 18VDC rechargeable batteries, one Milwaukee® 230 VAC battery charger, shoulder strap, and heavy-duty bag



**CT-2940/LE Crimping Tool**

- 136 Kn (15 ton) output
- Provided with two Milwaukee® M18™ XC high capacity RED lithium-ion 18VDC rechargeable batteries, one Milwaukee® 230 VAC battery charger, shoulder strap, and plastic tool case

For complete tool information please visit: [www.panduit.com/lithium-iontools](http://www.panduit.com/lithium-iontools)

Panduit offers comprehensive innovative solutions to optimize the connecting, routing, bundling, protecting, and identification of the physical infrastructure for lower total cost of ownership.



**Power Connectors**

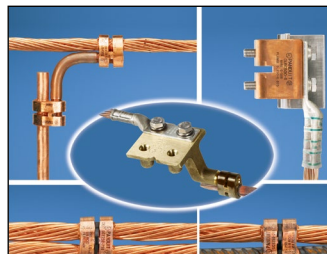

**Grounding Solutions**



**Terminals and Ferrules**



**Wiring Duct**

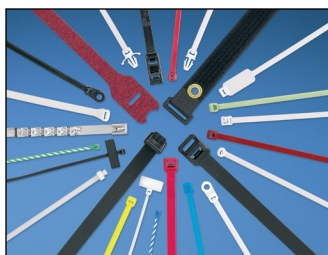

**Cable Ties**

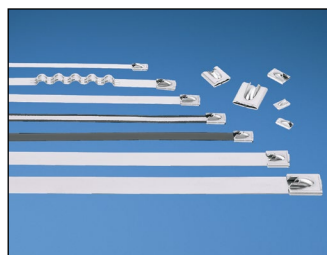

**Stainless Steel System**



**Abrasion Protection**



**Identification and Safety**

## WORLDWIDE SUBSIDIARIES AND SALES OFFICES

PANDUIT CANADA  
Markham, Ontario  
cs-cdn@panduit.com  
Phone: 800.777.3300

PANDUIT EUROPE LTD.  
London, UK  
cs-emea@panduit.com  
Phone: 44.20.8601.7200

PANDUIT SINGAPORE PTE. LTD.  
Republic of Singapore  
cs-ap@panduit.com  
Phone: 65.6305.7575

PANDUIT JAPAN  
Tokyo, Japan  
cs-japan@panduit.com  
Phone: 81.3.6863.6000

PANDUIT LATIN AMERICA  
Guadalajara, Mexico  
cs-la@panduit.com  
Phone: 52.33.3777.6000

PANDUIT AUSTRALIA PTY. LTD.  
Victoria, Australia  
cs-aus@panduit.com  
Phone: 61.3.9794.9020

For a copy of Panduit product warranties, log on to [www.panduit.com/warranty](http://www.panduit.com/warranty)

# PANDUIT®

For more information  
Visit us at [www.panduit.com](http://www.panduit.com)  
Contact Customer Service by email: [cs@panduit.com](mailto:cs@panduit.com)  
or by phone: 800.777.3300

©2016 Panduit Corp.  
ALL RIGHTS RESERVED.  
PCCB13--WW-ENG  
1/2016