

Minimizing Installed Cost of
High Speed Data Center
Engineered Links

Introduction

The performance and reliability of cabling infrastructure supporting critical applications within the data center are of paramount importance. For new high-speed optical networks such as 100 Gb/s Ethernet and 128 Gb/s Fibre Channel, it is critical for network stakeholders to have accurate knowledge of the fiber cable plant performance against the application standards. It is also very important to assure that customer deployed links present a warrantable solution compatible with cabling standards.

As the performance requirements for networks have advanced, the specifications on the constituent components (i.e., connectors deployed in permanent links) have become more stringent. Since the standardization of 1 Gb/s Ethernet (i.e., 100GBASE-SX) in 2002, the 3.56dB total Channel Insertion Loss (CIL) for 50/125 μ m multimode fiber has been reduced to 1.9dB for 40GBASE-SR4 (and 100GBASE-SR10). For these, a maximum total connector loss of 1.0dB is required for a 150m OM4 channel that may contain multiple connector interfaces.

Current plug/play multimode structured cabling systems built around LC and MTP connector systems have little insertion loss compared to the required cabling and component standards. TIA 568 and the application standards (Ethernet and Fibre Channel) require that no mated connector pair exceed 0.75dB Insertion Loss (IL). State-of-the-art multimode LC connectors have average losses less than 0.1dB and many vendors offer 'ultra' performance MPO connectors that show no more than 0.25dB Insertion Loss (when mated against a reference connector).

In the factory, the most accepted method of measuring the insertion loss of connectors is the one-jumper reference patch cord method (as specified in TIA FOTP-171). In this method, a single well-controlled, nearly ideal patch cord is the test interface. The installer measures performance for each connector. Since installers measure each connector using a nearly ideal patch cord, there is high internal measurement repeatability and reproducibility between multiple suppliers of connectivity, and across many customers when such connectivity exists in permanent links.

In North America, the predominant method for field-testing fiber optic links is the two-jumper reference method. This is a manifestation of legacy test equipment with SC connectors and has a significant impact on the efficacy of field testing of links with LC or MPO connectors. The potential to produce false fail results (link indicates fail, but truly passing) and false passing results (link indicates pass, but truly failing) scales directly with the capability of testing in the field. False fail results impact the customer's ability to deploy links in a timely fashion and can divert connectivity supplier monies wrongly (material and labor hours). False pass results can present link reliability issues and potential warranty claims against connectivity suppliers.

For example, to reliably measure the loss of a 30m OM3 permanent link in the field to the TIA and IEC standards requirements, where the expected total loss is a little over 1.6dB, the required measurement system repeatability and reproducibility would be a small fraction of 1.6dB (less than 0.2dB based on multiple standard deviations of measurement error). Permanent links built with low-loss multimode fiber (MMF) and these connector systems to support higher speed protocols require compliance with tight customer and industry specifications and very accurate/capable insertion-loss measurement processes.

These requirements raise two important questions which this paper examines.

- What is the most accurate and capable measurement technique for higher speed multimode links?
- What are the best industry practices to assure that remediation of links due to measurement errors and costs are at a minimum?

Permanent Link

ISO/IEC and TIA standards define the permanent link as the permanent fiber cabling infrastructure over which the active equipment must communicate. This does not include equipment patch cords to connect the active network devices in equipment distribution areas or the patch cords in cross-connect patch areas (Figure 1).

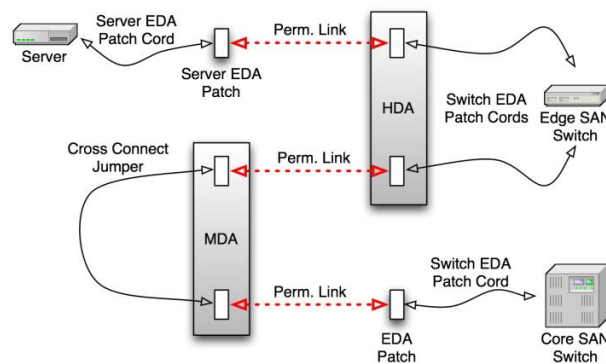

Figure 1. Storage area network cable plant permanent links (red).

ISO/IEC and TIA standards use permanent link testing to verify the performance of the fixed (permanent) segments of installed cabling as accurately as possible. Completion of this testing provides assurance that permanent links that pass standards-based (or application-based) limits can be configured into a passing channel by adding quality patch cords.

Channel

ISO/IEC and TIA standards define the channel as the completed fiber structured cabling over which the active equipment must communicate. This end-to-end link includes equipment patch cords to connect the active network devices in equipment distribution areas (switch to switch or switch to host), and the patch cords in the

Minimizing Installed Cost of High Speed Data Center Engineered Links

cross-connect patch. These patch cords are optional and located in the horizontal distribution area (HDA) and/or main distribution area (MDA) (Figure 2).

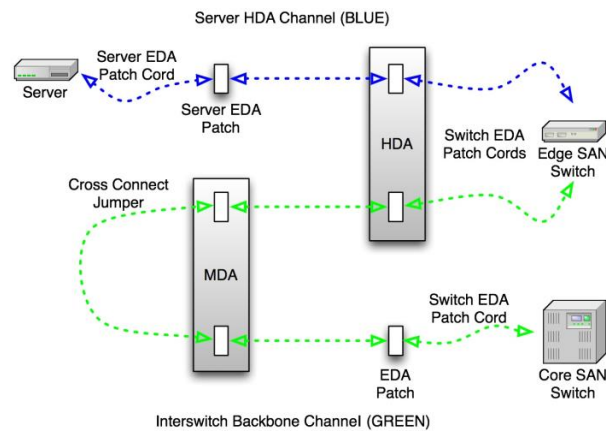

Figure 2. Storage area network cable plant channel (blue & green).

Network functionality and signal integrity rely on the channel performance (the completed end-to-end link). Installation and test personnel do not measure the end-to-end loss of the complete channel with all equipment distribution area (EDA) cords and cross-connect cables in place.

Installers connect EDA cords and cross-connect cables after they complete and test the permanent cabling installation, which is subject to Moves, Adds and Changes (MACs) throughout the cabling system's lifetime. Therefore, it is necessary to certify that the permanent link cabling infrastructure meets the standards and/or applications defined performance level (whichever is stricter) to assure adequate system headroom when IT personnel performs MACs.

No standards address application-based channel test limits other than the extension of the permanent link test limits (with the addition of the connector losses in patch cords). The application link power budget (e.g., Ethernet, Fibre Channel, etc.) does not include the connectors attached to equipment on either end of the link as insertion loss milestones. Installers build these connectors into the link power budget as minimum transmitter power (-dBm) into the fiber and receiver minimum sensitivity in Amps/Watts. So, the number of connectors in the channel is the total number of mated pairs of connectors. Connector terminations into the receptacles of the transceivers are not mated pairs.

Typically, channel certification using Power Meter and Light Source (PMLS or LSPM) methods is at the request of network owners and/or specifiers and brings no additional value beyond the initial permanent link testing. Installers deploy these methods as a troubleshooting tool for channel functionality.

Application Standards Link Budgets

Installers determine the overall power budget for an optical channel link during the development phase of the associated application standard, and they base it on the magnitude of seven principal optical impairments (or power penalties), and the maximum channel reach. These penalties include Inter-symbol Interference (ISI), Mode Partition Noise (MPN), Modal Noise (MN), Relative Intensity Noise, (RIN) Reflection Noise (RN), Polarization Noise (PN), and Insertion Loss (IL).

Most of these optical impairments are small (<0.3dB) and this paper does not address them. However, ISI and IL contribute large optical penalties and therefore, are the two primary impairments that limit channel performance (or channel reach). The quality and practices for constructing the physical link strongly influence ISI and IL.

When an optical pulse propagates through a fiber channel, its shape broadens in time due to bandwidth limitation in the transmitter, fiber, and receiver. The optical pulse representing each data bit or “symbol” spreads in time and overlaps the adjacent symbols to the degree that the receiver cannot reliably distinguish between changes in the individual symbols or signal elements. The power penalty due to this effect is known as ISI, which affects the temporal characteristics of the signal pulses, resulting in signal dispersion and timing jitter at the receiver. ISI contributes the largest optical power penalty in high-speed MMF transmission systems.

To meet the ISI channel requirement, each standard such as 10 Gb/s Ethernet (IEEE 802.3ae) or 8 Gb/s Fibre Channel (FC-4) specifies the minimum fiber bandwidth (or maximum dispersion) necessary to comply with the system ISI requirements and ensures error-free system performance. Effective Modal Bandwidth (EMB) determines the fiber bandwidth, and high-speed systems (>10 Gb/s) must achieve a minimum EMB of 2000 MHz.km for laser-optimized OM3 MMF, and 4700 MHz.km for OM4 MMF.

IL is the second critical parameter that determines a channel link’s performance. The two sources of IL are loss at the connector-to-connector interfaces and loss or attenuation within the fiber due to the absorption and scattering of light as it propagates. For high-performance and reliable 10 Gb/s network operation, installers should minimize both loss sources by selecting high quality, low IL connectors, patch cords, cassettes, and high-performance MMF. Figure 3 compares the optical power penalties for a 10 Gb/s Ethernet channel link as specified in IEEE 802.3ae for 10GBASE-SR. The total power budget for this channel link is 7.3dB.

Minimizing Installed Cost of High Speed Data Center Engineered Links

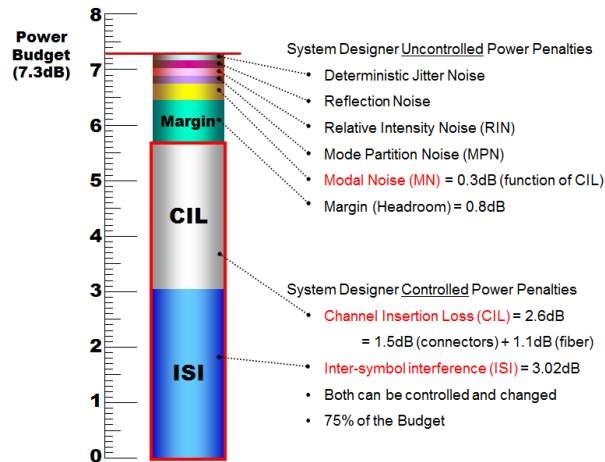

Figure 3. Optical channel budget for 10 Gb/s Ethernet (10GBASE-SR).

In theory, installers can trade off cable attenuation for connector IL, or ISI power penalties for IL; however, they must do this with caution. Engineered links are those channels making tradeoffs of parameters.

As an example, consider an OM4 (M5F in Fibre Channel), 16 Gb/s Fibre Channel link with an installed reach of 50m (with 2.4dB of total connector insertion loss). This is a third of the maximum specified reach of a 150m engineered link with 1.0dB of connector insertion loss (Table 1).

Table 1. 16Gb/s Fibre Channel reach/power budget vs. total connector insertion loss.

Fiber Type	Distance (m) / Loss Budget (dB)				
	3.0 dB	2.4 dB	2.0 dB	1.5 dB	1.0 dB
M5F (OM4)	NA	50 / 2.58	100 / 2.36	125 / 1.95	150 / 1.54
M5E (OM3)	NA	40 / 2.54	75 / 2.27	100 / 1.86	120 / 1.43
M5 (OM2)	NA	NA	25 / 2.09	35 / 1.63	40 / 1.14

ISI for this channel is significantly less than when it is at 150m. As a result, a larger connector IL of 2.4dB can be tolerated. Alternatively, installers can reduce the ISI penalty by using the increased fiber bandwidth of OM4. It is important to understand and quantify the permanent link certification limits within the LSPM test procedure. Installers must select the setup values for connector loss for engineered links to comply with the application standard if these limits are tighter than the relevant cabling standard. For example, the TIA/ISO typically states 0.75dB maximum per connector pair, but an engineered link may require 0.5dB maximum, therefore the application standard takes precedence.

The Emergence of Complex Engineered Links/Channels

Customers design engineered channels for solid reasons:

- The reach of the standards-based solutions for Ethernet and Fibre Channel does not fulfill requirements
- Customers like the flexibility and scalability of fiber structured cabling and by default will specify a Central Patching Location (CPL) that functions as a cross-connect facility for “any-to-any” MACs. Certain customers propagate this model into cross-connect zones/pods, which results in a concatenated main cross-connect and zone cross-connect. This pushes the boundaries of the espoused standards and introduces the need for engineering channels to suit, based on the deployment of high-performance fiber and/or ‘ultra’ low loss connector systems
- The customer designs a migratable cable plant for higher speed optics at some point and based on industry trends, more loss constrained channels

The second bullet point describes the core focus of this paper. Customers expect to validate ‘ultra’ low loss connectivity (built into an engineered channel) to the same performance limits as installers measure in the factory.

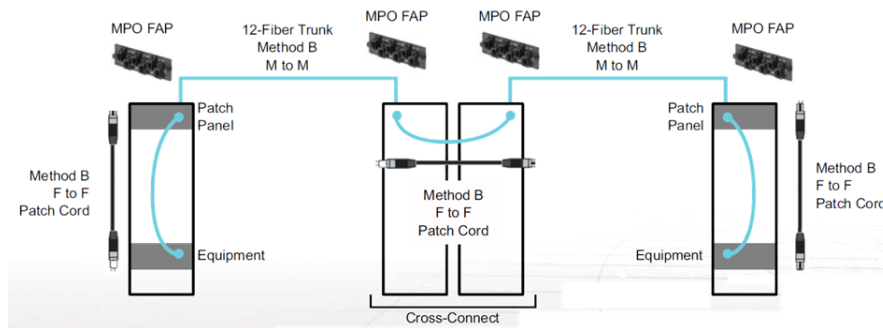

Figure 4. 40GBASE-SR4 engineered channel example.

Figure 4 illustrates how the customer designed a full cross-connect into the 40G SR4 channel to support port-mapping 40G core switches within a central patching location proximal to the core (full 12 fiber ribbon cable plant throughout terminated with MPO connectors that reach out to top of rack switches within the server pods). This customer’s longest channel for the end-to-end optics is 170m which is outside of the capability of the 150m OM4 channel designed with 1.0dB maximum connector loss in the IEEE 802.3ba standard (see a plot of connector loss and fiber type vs reach for the 802.3ba standard in Figure 5). As a result, the customer deploys “ultra-low loss” MPO connectors to assure channel integrity. These MPO connectors demonstrate a maximum insertion loss of 0.25dB (factory test results).

Minimizing Installed Cost of High Speed Data Center Engineered Links

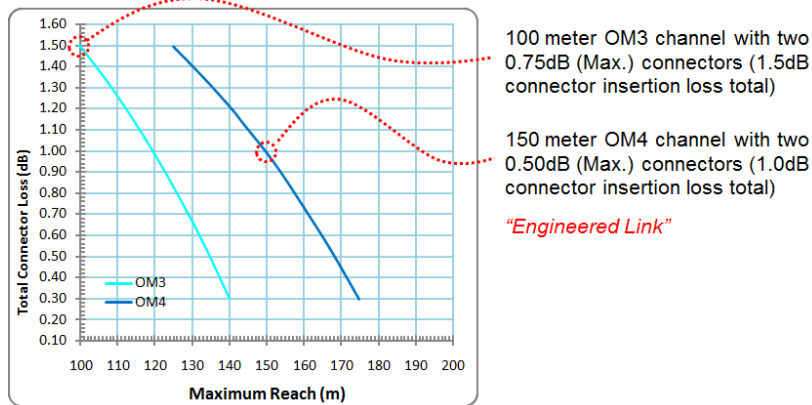

Figure 5. Extrapolation/Interpolation from IEEE model for various connector insertion loss values.

The design requires long trunk assemblies reaching out to the servers (150m max) and shorter trunks to connect between the core and cross-connect area (10m max). The customer then wants to qualify the two trunks (when mated into MPO fiber adapter panels) as permanent infrastructure links (Figure 6) to the manufacturer’s ‘ultra’ specifications (not the TIA limits). Therefore, the long trunk (on the left, below) and the short trunk (on the right, below) would yield the following engineered limits:

$$\text{Server Side Trunk test limit} = 2 \times 0.25\text{dB} + 0.15 \text{ km} \times 3.5\text{dB/km} = 1.03\text{dB}$$

$$\text{Core Side Trunk test limit} = 2 \times 0.25\text{dB} + 0.01 \text{ km} \times 3.5\text{dB/km} = 0.54\text{dB}$$

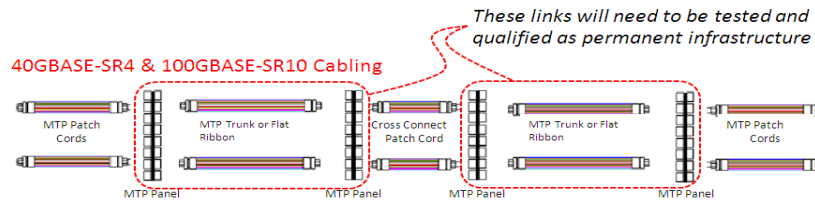

Figure 6. Parallel optics cross-connect cable plant.

If tested in the field against TIA/IEC guidelines, these links would yield:

$$\text{Server Side Trunk test limit} = 2 \times 0.75\text{dB} + 0.15 \text{ km} \times 3.5\text{dB/km} = 2.03\text{dB}$$

$$\text{Core Side Trunk test limit} = 2 \times 0.75\text{dB} + 0.01 \text{ km} \times 3.5\text{dB/km} = 1.54\text{dB}$$

The Real Capability (Repeatability & Reproducibility) of Field Test (vs. Factory Test)

ANSI/Automotive Industry Measurement Systems Analysis definitions of Gauge Repeatability and Reproducibility (GR&R) determine the meaning of measurement capability. With LSPM testing in the field, the gauge is the LSPM along with the reference cords that interface to the link under test.

Repeatability is the measurement variation obtained when one operator repeatedly measures the same item with the same test set.

Reproducibility is the variation due to different operators using the same test set to measure the same item.

The total variance of the actual link measurement (TV) is the sum of three components:

- The true variation present in the link - Product Variation (PV)
- Variation due to different test technicians (reproducibility) - 'Appraiser' Variation (AV)
- Variance of LSPM error (repeatability) - Equipment Variation (EV)

Such that:

$$TV = PV + AV + EV$$

To estimate these components of variation, operators perform a standard Gauge R&R study (GR&R). All such studies adhere to the following format:

- Select a fixed number of parts (in the plot below 12 fibers labeled 'A' through 'L')
- Select a fixed number of operators (in the plot below two technicians labeled '1' through '3')
- Each operator measures each of the parts a fixed number of times (3-5 times each, randomized)

Operators perform this analysis on standard LSPM test sets to determine how much of the total variation is assignable to technician practice and test set uncertainty. The hope is that the sum of AV and EV will be a small fraction of the tolerance (test limits) that operators are measuring. Industry experts peg this ratio (capability ratio) at a maximum of 0.3 (30% of the tolerance range in question).

For a test limit of 1.0dB, operators look for the sum of AV and EV to be less than 0.3dB. ANSI equates this to 5.15 sigmas or a standard deviation of measurement error of 0.06dB. Figure 7 shows sample output from a GR&R analysis on a typical LSPM.

Minimizing Installed Cost of High Speed Data Center Engineered Links

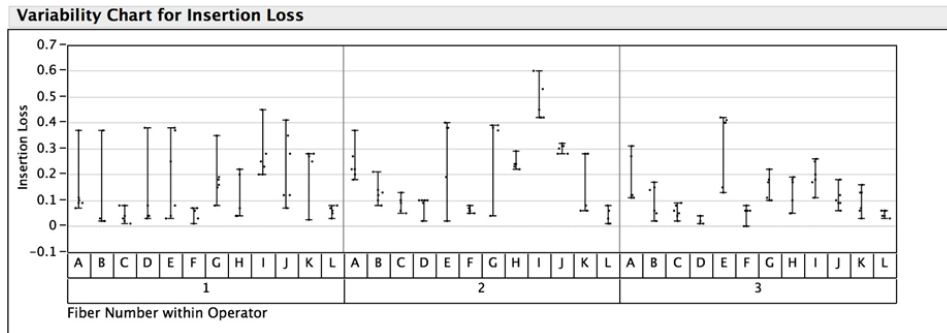
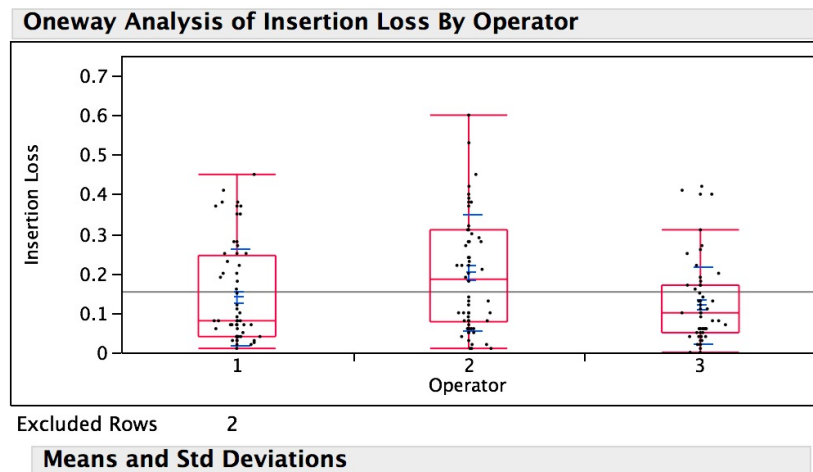

Figure 7. Sample output from a GR&R analysis on a typical LSPM.

This chart shows the results of a GR&R study performed on a dozen subject fibers ('A' through 'L') that three LSPM technicians measured 3-5 times. The technicians deployed three LSPM test sets and multiple reference grade cords in this study. The sequence of measurements was randomized among parts, technicians, LSPM sets, and reference cords. Whisker charts indicate the range of measurements for each technician measuring each fiber.

The differences among the operators when measuring the same fibers indicate a striking discrepancy between the mean link loss and the variability of the link loss (Figure 8):



Means and Std Deviations

Level	Number	Mean	Std Dev	Std Err		
				Mean	Lower 95%	Upper 95%
1	72	0.139653	0.123066	0.01450	0.11073	0.16857
2	70	0.201000	0.146299	0.01749	0.16612	0.23588
3	72	0.119444	0.097820	0.01153	0.09646	0.14243

Figure 8. Operator measurement variability.

Operator 2, when measuring the same fibers as Operator 3 has almost twice as much link loss and about 50% more variation of link loss. The summary GR&R results shown in Figure 9 indicate a total measurement variation for the link loss (5.15 sigmas) of 0.536dB or approximately plus/minus 0.27dB.

This is the total expected range of measurement error for a single link loss measurement. As a result, there are minimal measurement errors with the LSPM unit if the limits of test are approximately 1.8dB (30% or less of the limit assigned to GR&R as per the ANSI requirements).

Measurement Source		(5.15*StdDev)	Tolerance	
Repeatability	(EV)	0.43588171	33.53	Equipment Variation
Reproducibility	(AV)	0.31118821	23.94	Appraiser Variation
Operator		0.20651280	15.89	
Operator*Fiber Number		0.23278867	17.91	
Gauge R&R	(RR)	0.53556602	41.20	Measurement Variation
Part Variation	(PV)	0.42129141	32.41	Part Variation
Total Variation	(TV)	0.68140841	52.42	Total Variation
5.15	k			
78.5969	% Gauge R&R = 100*(RR/TV)			

Figure 9. Variability chart for IL – GR&R.

Classifying Errors in the Field (False Positives and False Negatives)

False fail - Link indicates fail but truly passing - This can impact the customer's ability to deploy links in a timely manner. In this case, money is unnecessarily spent in remediating links that do not require it.

False pass - Link indicates pass but truly failing - Presents link reliability issues and potential warranty claims against cabling suppliers. This is a "Day Two" issue after link commissioning, as initial good links impinge on the signal integrity required by the communication protocol.

Both issues relate to the ability of the measurement system to discriminate pass from fail. This discrimination is a result of the capability (repeatability and reproducibility) and accuracy (bias due to referencing, etc.) of the test set.

Figure 10 depicts a buildup of the previous 40G scenario that demonstrates how false positives and negatives occur due to an incapable gauge and a distribution of link losses that is pushed near the limit of test. This is not unrealistic in today's world of complex architectures and multiple connector 'hops' with associated losses.

In a typical data center link of 10m of OM4 fiber terminated on each end with 'ultra' level MPO connectors (at <0.25dB each per the manufacturer), the standards (and customer) expectation of a passing link loss is approximately 0.54dB max (the red line shown in Figure 10).

Minimizing Installed Cost of High Speed Data Center Engineered Links

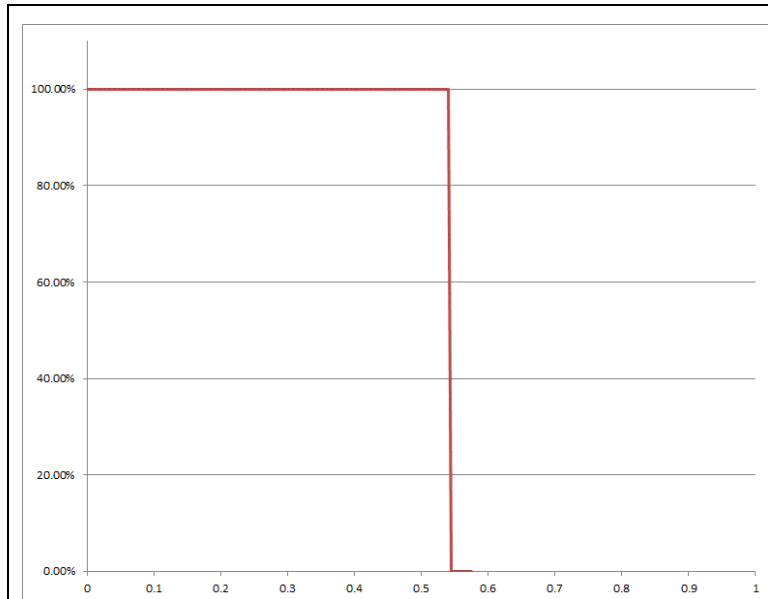

A desirable measurement system will reject any links above 0.54dB and pass all links below 0.54dB. It will not create any false fails or negatives in the process.

Such a preferred gauge is depicted to the left, in terms of probability of acceptance on the vertical axis and link loss on the horizontal axis.

This is an idealized and perfect gauge that demonstrates no bias (or offset) because of poor referencing.

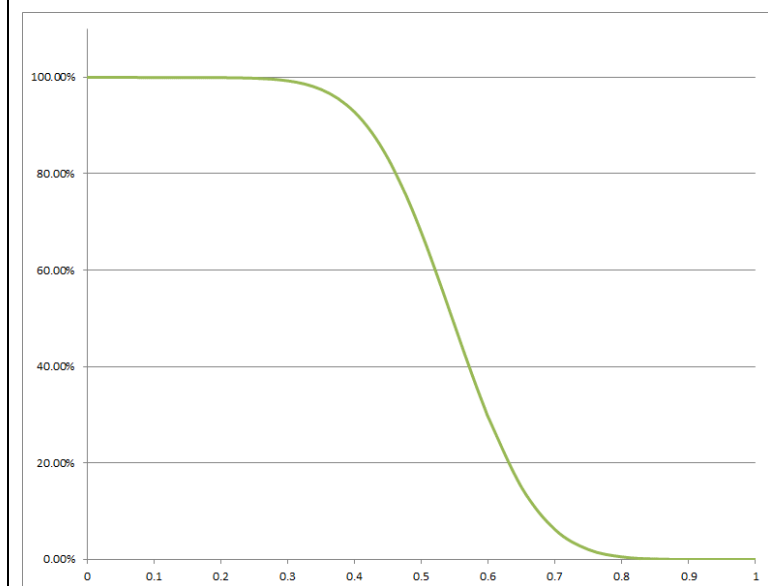

The green curve to the left is more indicative of a "real gauge" that has bias due to referencing and gauge capability that is not ideal.

The gauge capability (GR&R) for the gauge depicted is related to the width of the transition from $P(\text{Accept})=100\%$ to $P(\text{Accept})=0\%$; for the figure, this is approximately 0.6dB.

This is based on the GR&R study shown in Figure 9.

Minimizing Installed Cost of High Speed Data Center Engineered Links

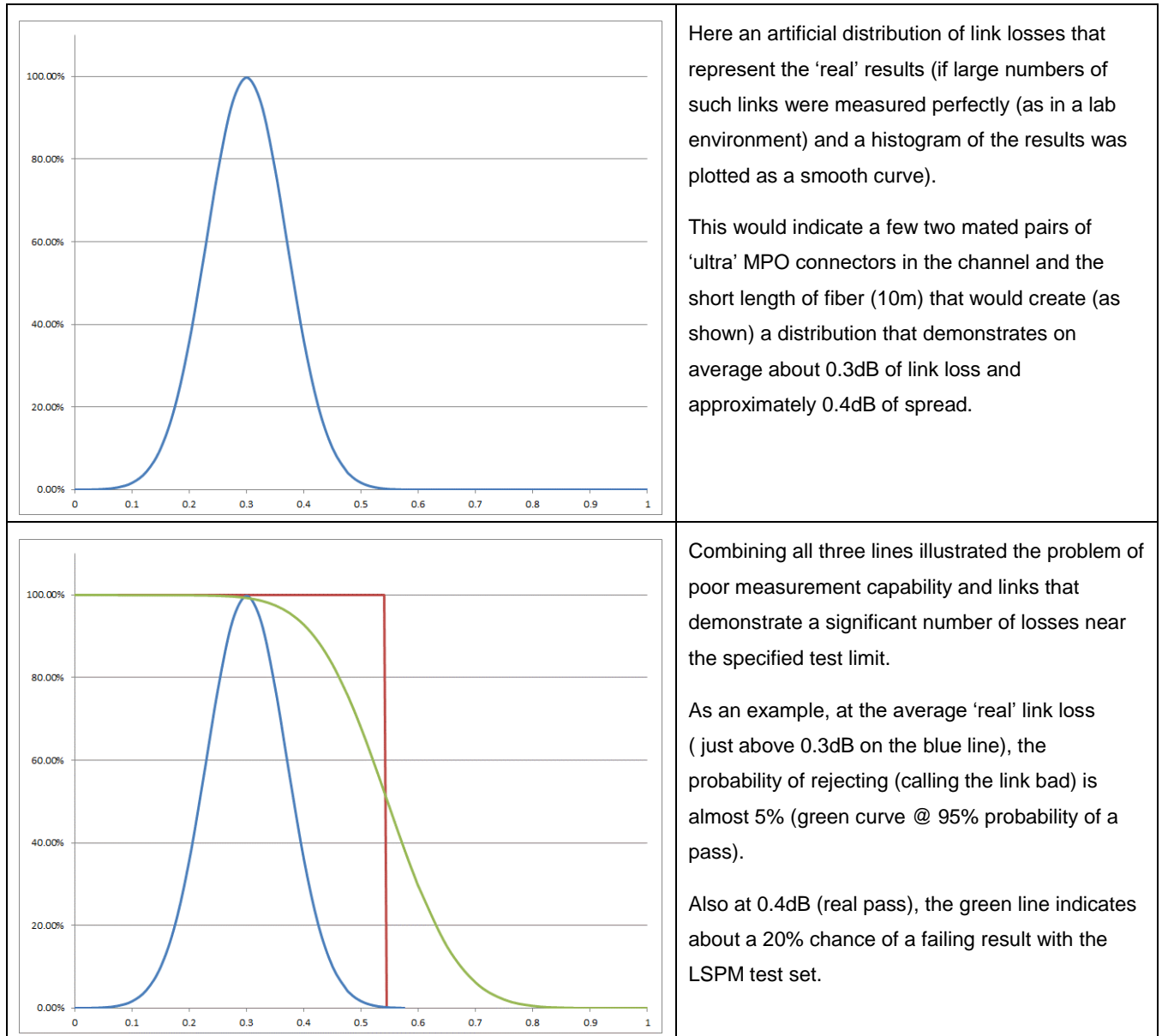

Figure 10. Operating characteristic curves for light source/power meter.

The gauge in Figure 10 would err on the side of producing many false fails (links that are good but the measurement test set deems them as fail). This effect would not occur if all the links produced were less than about 0.2dB (where there is no risk of measurement decision error). But, for marginally passing links (between 0.54dB and 1.6dB link loss) there is an increased probability of false fails.

Shifting the Gauge Performance Curve (green line) portrayed in the scenario above to the right would have the reverse effect and would produce many false passes (again mitigated by the true level of link loss that the gauge measures). This could happen if referencing is poor or 'biased' downward by end contamination after referencing or bent reference cords (during the reference sequence) that are straightened during link measurement.

Modified Engineered Limits – Guardbanding

When there is high measurement uncertainty as in the GR&R study described above (0.54dB), it is prudent to consider a new approach to mitigating cost and effort in commissioning cable plants with tight limits.

The assumption is that there is an understanding of the capability index of the LSPM test set in the light of proposed test limits. There is also an assumption that the manufacturer of the plug/play pre-terminated system components (trunks, harnesses, cassettes, etc.) has a much better system of control over IL measurements. This includes advanced capabilities over monitoring on an ongoing basis the efficacy of the reference cords in use on the manufacturing floor and checks and balances (i.e., measurement process control) over the measurement system in its entirety. In addition, most quality manufacturers of optical assemblies perform testing, inspection, and packaging in clean rooms or at least laminar flow head facilities (Figure 11).

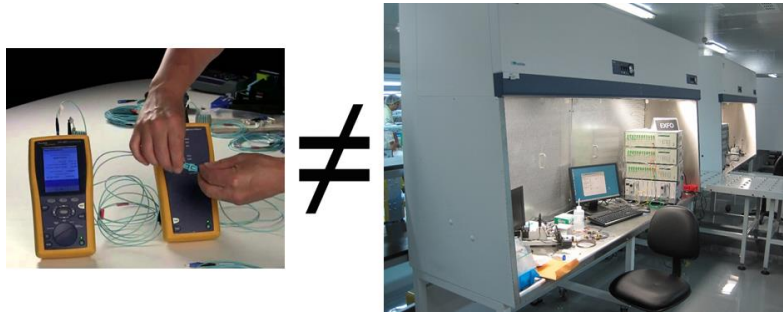

Figure 11. Field vs. factory test capability.

Expanding the test limits in a logical fashion with the knowledge of the incapability of the test system when combined with multiple operators, test sets, and reference cords can minimize the costs associated with commissioning such engineered links. The logical approach is to split the GR&R in half and 'Guardband' the test limits by this amount.

For this example, knowing that the GR&R is approximately 0.6dB, operators would shift the limits of the LSPM test by 0.3dB, yielding a new test limit at 0.84dB (0.54dB + 0.3dB). This would shift the gauge performance curve previously generated (the green curve) to the right by 0.3dB (Figure 12).

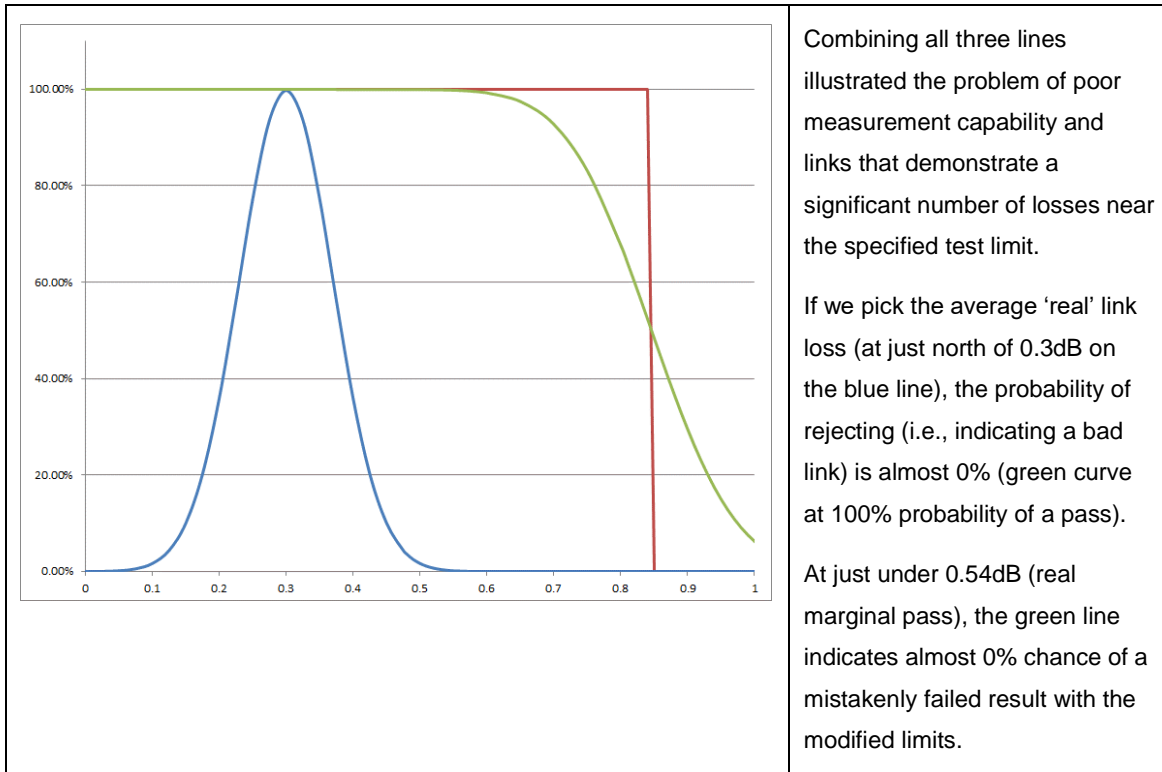

Figure 12. Guardbanded operating characteristic curve for light source/power meter.

Case Studies – Real Field Data

Case Study #1: Business Case for Reference Grade Jumpers

A large Global 500 account indicated that a third party uncovered link failures during audit testing for field installed 10G multimode fiber at one of its data centers.

This third-party contractor was randomly selecting permanent links commissioned as “known good” by a different crew from the same contractor. These links contained two connector pairs and two fusion splices (in fiber trays). The contractor pulled small fiber count multimode premise distribution cable into place and fusion spliced it in the fiber trays to MMF pigtailed to form permanent link segments.

The customer specification artificially set the Link Loss Budget for these links to approximately 0.8dB. The specification only allocated one connector @ 0.75dB, set no allocation for fusion splices, and set minimal contribution for fiber attenuation since these links were <50m in length).

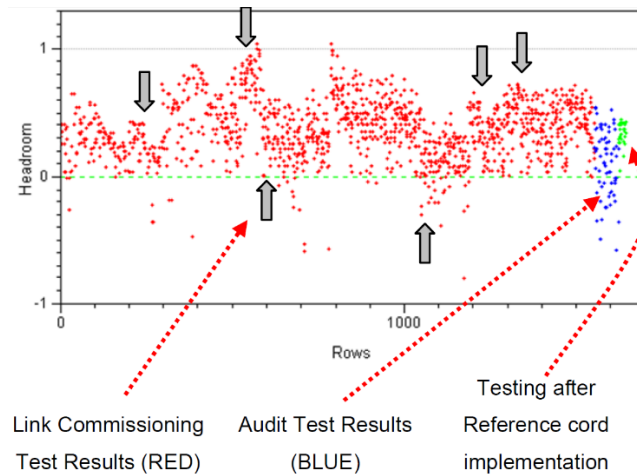

Figure 13. Headroom data.

Figure 13 shows that only about 5% of the links failed the original link commissioning testing (red) with negative headroom and that the average link result between the two test crews (for the same links, see below) yields significantly different results (>0.3dB on average).

Results:

- Substantial difference in average headroom between audit and commissioning permanent link tests
- Extremely poor reproducibility > 1dB (based on 5.15 sigmas)
- Variability due to reproducibility (between test crews) and repeatability (within test crews) consumes the 0.8dB power budget

The customer “blew the alarm” when the sampling that the crew performed during audit testing indicated that approximately 40-50% of the links were failing testing (blue) with negative headroom. When mapping the measurements of links that the crew sampled against the original results for those same links, it is expected that for a capable and repeatable measurement process there would be a strong correlation between these paired measurements. However, there is an absolute lack of correlation between first measurements and the audit results (Figure 14).

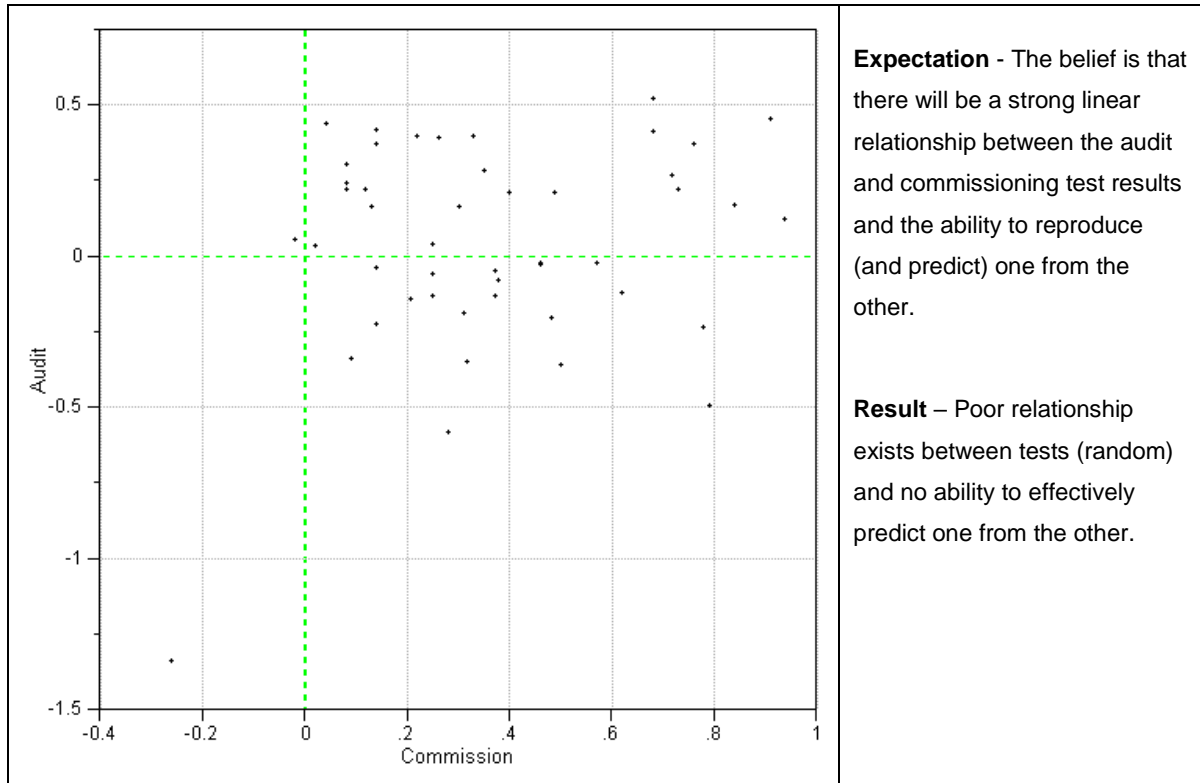

Figure 14. Plot correlating first commissioned measurements against audit results.

Operators retested all audited links with the best practices, with the main change being the use of reference grade test jumpers (which were not in place in the commissioning and audit testing). Operators informed the customer that such cords are required in standardized test methods for measuring fiber connectors and cables assemblies (e.g., TIA/EIA-455-171A) and are defined in terms of geometry and optical performance in other standards (e.g., ISO/IEC 14763-3 and TIA/EIA-455-171A Annex 'A').

As a result, all the audited links passed headroom specifications and demonstrated about a quarter of the variability of both previous test efforts (shown in green in Figure 13).

Case Study #2: The Requirement for Cleaning and Inspection Best Practices

A large government account encountered such a high failure rate of link failures for pre-terminated, cassette-based 10G multimode plug/play fiber product at its data center, that operators halted testing until they could find and rectify the root cause (50-60% failure rate of links before testing stopped). The raw test data from LSPM testers was examined by rack unit numbering against the failure rate of links. Racks were tested in sequence by the rack unit numbering sequence:

- a. KK01/SK02 Units tested first on 5/6/09 - 9.08am
- b. KK13/SK12 Units tested last on 5/13/09 - 9.01am
- c. Patching units between KK01/SK02 and KK13/SK12 tested in sequence

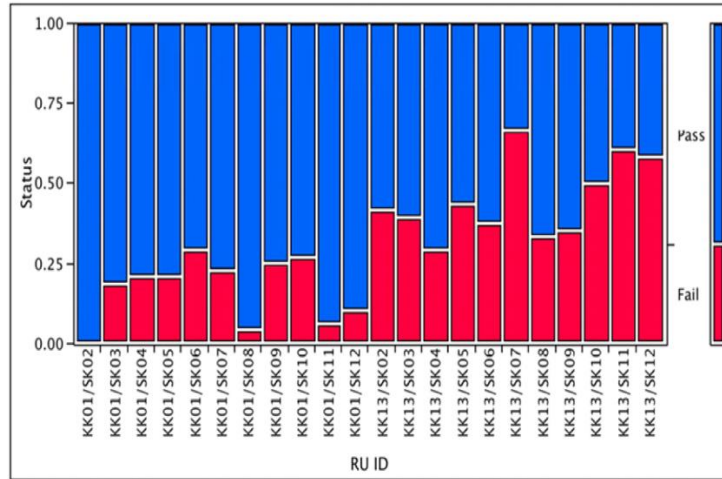

Figure 15. Plot showing link fail rate (% , in red) and link pass rate (% , in blue) vs. rack location (RU ID).

Notes:

- 1. Scale "status" is link failure probability (1 = 100% failures)
- 2. Red is coded as percentage of link failures for a specific link location
- 3. Blue is coded as percentage of link passes for a specific link location
- 4. Testing sequence progress in time is left to right along the horizontal axis

Figure 15 shows the dependence of link failure rate on time stamping data from LSPM test set (coding of link endpoint IDs matched to time stamp - time stamps line up with rack unit numbering sequence as shown in the plot). The plot indicates that the link failure rate went from 0% to approximately 50% of the fibers tested over the time of testing (approximately the first 60 fibers tested in sequence all passed).

It is unlikely that plug/play pre-terminated products would produce such a linearly increasing failure rate. Therefore, this does not relate to the natural product variation. There are systemic testing issues here such as damaged reference cords or contamination issues.

Validation of this premise was confirmed by reviewing the time stamped data from the LSPM test sets the installers used. Figure 16 shows the time-stamped headroom scatterplots of the collected data. The 13 scatters up to and including 11/03/2010 are represented by the data in Figure 16.

Minimizing Installed Cost of High Speed Data Center Engineered Links

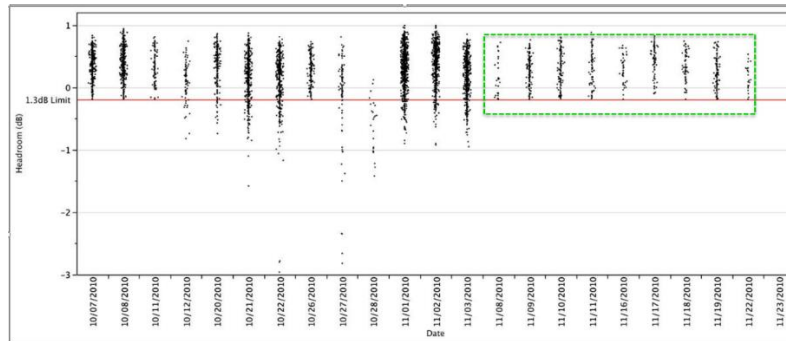

Figure 16. Time-based variability of LSPM data.

All discrepant links were retested with the best practices. The main changes were inspection, cleaning, and testing of reference patch cords. As a result, all links that previously failed (as indicated in the plot) passed with significant headroom to the standard when retested. A sample of the retested links in the scatters are inside of the green dashed box in Figure 16.

This customer has since adopted these cleaning and inspection practices on reference patch cords and links under test. This change has had a significant impact on the customer's measurement capability, specifically stability of measurements.

Case study #3 - Variability Amongst Test Technicians in the Field

A large bank in the Americas considered returning large quantities of pre-terminated assemblies (trunks, fan-outs, harnesses, and cords) based on onsite measurements of each component. This was a function of troubleshooting at the component level of various channels built on plug/play products. When link testing turned for the worse, installers set aside the channel components and measured for loss.

The plot below is typical of data collected from LSPM test sets and indicates a huge disparity in the variability among technicians performing the field tests of fan-outs.

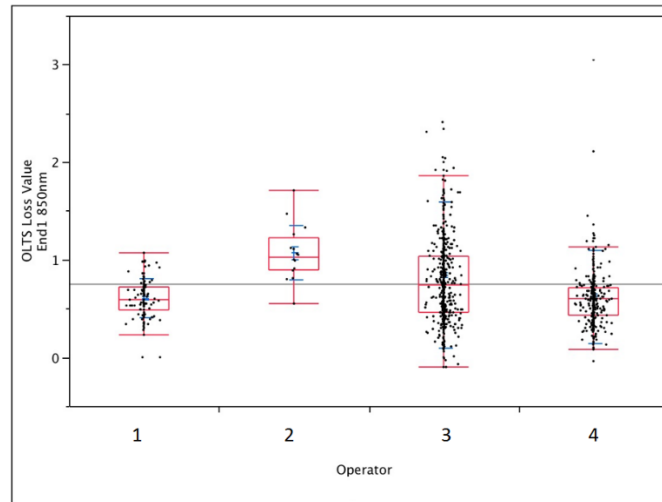

Figure 3. Box-Whisker chart of fan-out IL vs. operator (measuring same product).

Testing shows a significant difference in the skill level of individual operators performing field testing onsite (Figure 17). There was confusion about determining a good reference. Several of the operators involved had never learned the process of testing the reference cord using a single jumper reference and component test. For most, this was a practice that seemed unimportant to the job. Operators were also confused regarding reference check limits.

Because of this engagement, key personnel was retrained in proper practice of using, maintaining, and qualifying reference cords to industry standards.

Increasing the Efficacy of Field Test

To increase the effectiveness of field tests, consider the following:

1. Use TIA-526-14-B Annex 'A' (one jumper method) as the default method of validating permanent link performance for data center links with multimode fiber. Test equipment (receive head) must be equipped with link under test connectors.
2. Use Encircled Flux launch conditioning cords (or mandrel wraps) per test equipment manufacturer's guidelines to produce standards compliant launch conditions. This reduces the variability of tests, particularly between test sets.
3. Use precision or reference grade launch jumpers in all cases. Ensure that mechanical and optical characteristics of these conform to local standards. Reference-grade patch cords are required for accurate characterization of link loss in fiber-based permanent links. These cords are used as consumable items in the commissioning and qualification of links (after initial installation). Reference-grade patch

cords minimize total installed cost by providing excellent measurement capability for tight application power loss budgets.

4. A reference patch cord contains connectors which minimize the mean and standard deviation of insertion loss when mated against a large population of sample connectors. These reference connectors have nominal optical and geometrical characteristics (e.g., Numerical Aperture and Core/Ferrule concentricity). They produce “near zero” loss when mated against other reference connectors. These reference grade patch cords assure accuracy (in referencing) and gauge repeatability (replication of link tests under the same reference) and reproducibility (replication of test results across multiple test sets and references).
 - Use TIA FOTP-171 (one jumper method) to qualify precision jumper connectors on a component basis (instead of a fixed number of mating cycles)
 - Longevity and durability of such cords are also discussed in standards (e.g., Telcordia GR 326) to provide guidance on maintenance of working reference cords. It is the responsibility of the individuals performing testing to assess the integrity of the reference cords.
 - Use TIA FOTP-171 (one jumper method) to qualify reference cords on a ‘schedule’ and when reference cords are in question (instead of a fixed number of mating cycles). Deciding when a reference cord is best taken out of service can be determined by performing one jumper component insertion loss on all reference cord ends that interface to links under test with a ‘master’ cord that is purpose-built to qualify working reference cords. If possible, chart or log these measurements to determine the state of control of the reference.

Be sure to allocate the actual number of mated pairs of connectors present in the channel into the power budget (measured against reference connectors), regardless of the chosen link measurement technique.

For loss challenged links (tight engineered links), assess the test limits against the GR&R of the test set. If the GR&R significantly infringes the capability to test to the limits, negotiate with the customer to modify limits upward by one-half of the GR&R. This is a good point to engage the structured cabling supplier to provide guidance and a technical bridge between the end customer and the SI/installer.

Most importantly, adhere to good cleaning and inspection practices as outlined in connector component and test equipment manufacturers’ guidelines (when in doubt, clean it). This applies to anything that touches the link under test, including the test equipment reference cords, visual inspection equipment, etc.

Referenced Resources

- [FOTP-171, User's Guide to Fiber Optic System Design and Installation](#), The Fiber Optic Association.
- TIA 568, Commercial Building Telecommunications Cabling Standard
- TIA/EIA-455-171A, Attenuation by Substitution Measurement for Short-Length Multimode Graded-Index and Single Mode Optical Fiber Cable Assemblies
- ISO/IEC 14763-3, Testing Optical Fibre Cabling - included in TIA 568
- TIA/EIA-455-171A Annex 'A', Attenuation by Substitution Measurement for Short-Length Multimode Graded-Index and Single Mode Optical Fiber Cable Assemblies
- TIA-526-14-B Annex 'A', Optical Power Loss Measurements of Installed Multimode Fiber Cable Plant; IEC 61280-4-1 edition 2, Fibre-Optic Communications Subsystems Test Procedure Part 4-1: Installed Cable Plant - Multimode Attenuation Measurement
- IEEE 802.3ae, 10 Gigabit Ethernet Technology
- Telcordia GR 326, Generic Requirements for Single-Mode Optical Connectors and Jumper Assemblies

About Panduit

Panduit enables data centers to realize their full potential through an integrated stack of physical and intelligent infrastructure solutions that drive actionable performance gains and efficiencies to reduce operating costs and maximize capacity of power, cooling, space, and connectivity for the greatest ROI. Bridging physical equipment (cabinets, copper and fiber connectivity, and pathways), intelligent solutions (monitored rack PDUs, intelligent patching, and DCIM software), and professional services, Panduit offers the most comprehensive integrated data center portfolios available from one single source vendor. Complemented further by strong technology partnerships, Panduit integrated data center solutions are designed to answer increasing demand for IT services and technologies, while simplifying growing complexity in the data center design.

www.panduit.com · cs@panduit.com